



Moderne Licht-Technik AG
Tägerhardstrasse 110
5430 Wettingen

056 427 02 50
info@mlt-licht.ch
www.mlt-licht.ch

*Gutes Licht
ist kein Zufall*

The background of the page features a large, abstract image of a light fixture array. The lights are arranged in a grid pattern, with a perspective that makes the lines converge towards the top right. The lights are blurred, creating a bokeh effect. A large, solid blue triangle is overlaid on the left side of the page, pointing towards the bottom right.

SORTIMENTSÜBERSICHT

*Gutes Licht
ist kein Zufall*

FÜR ALUMINIUM-
MONTAGEPROFILE

ALUMINIUM-MONTAGEPROFILE | AUF EINEN BLICK

GARLIANO

19 × 22 mm

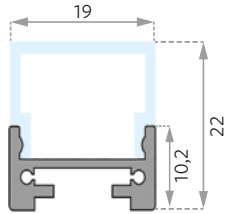

GARGANO

17,92 × 15,5 mm

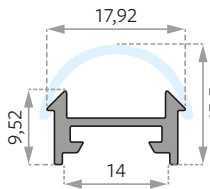

LP-U2020

20 × 20 mm

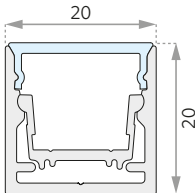

SMALL WING

24,9–18,8 × 13 mm

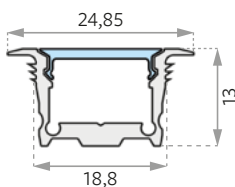

SMALL CORNER

22,8 × 22,8 mm

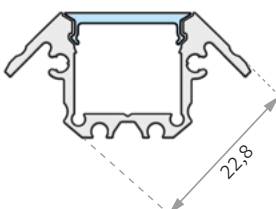

BARDOLINO H-PROFIL

18,4 × 30 mm

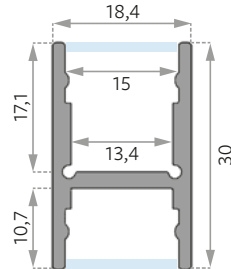

BARDOLINO DUO

16,6 × 51 mm

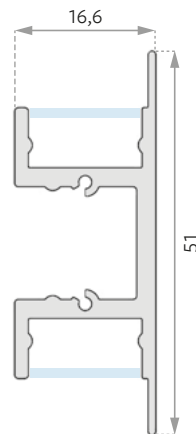

SMALL FLAT

17,3 × 9,6 mm

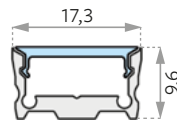

SMALL U

17,3 × 16 mm

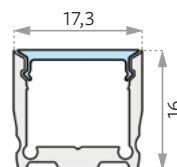

MEDIUM SQUARE

27 × 23,8 mm

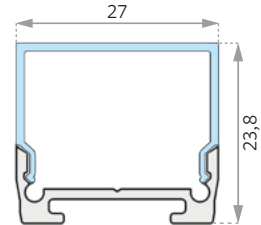

MEDIUM FLAT

27 × 10,2 mm

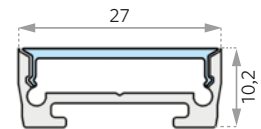

MEDIUM U

27 × 25,9 mm

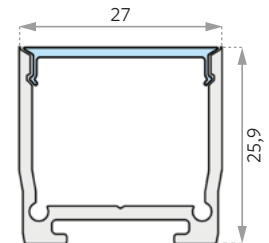

MEDIUM WING

40–27 × 25,9 mm

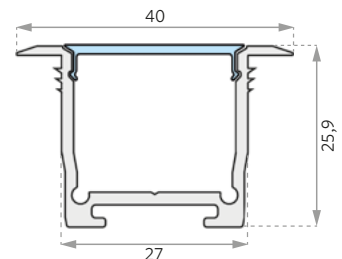

LP-U3030

30×30 mm

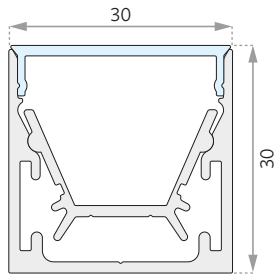

ANGOLO ECK-PROFIL

30×30 mm

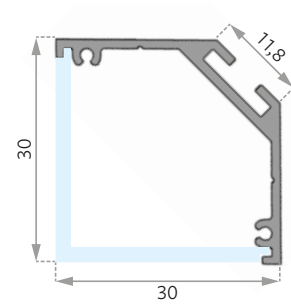

EPIC III

39,5×62,8 mm

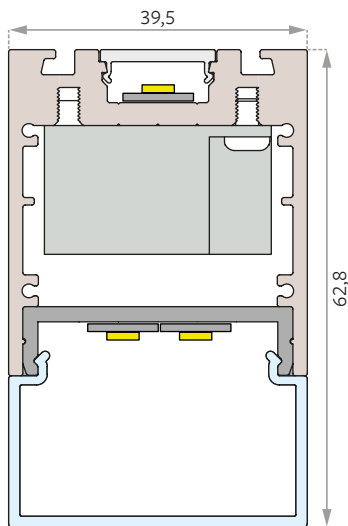

EPIC IV

39,5×43,0 mm

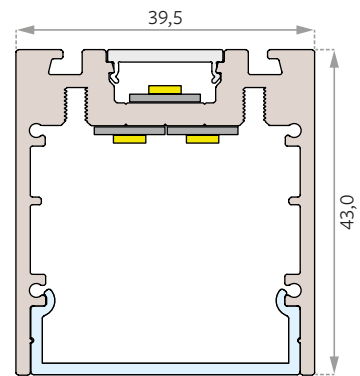

EPIC I

39,5×44,15 mm

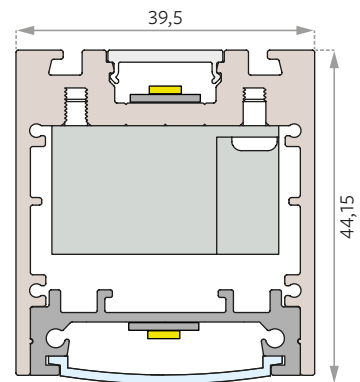

EINLEGE- UND GRUNDPROFILE | FÜR SICHTBETON/WEISSPUTZ (VARIABLE LÄNGEN)

VISTO 30

Konverter extern

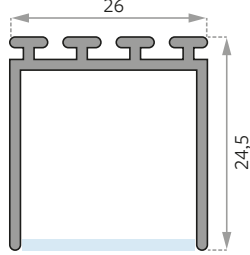
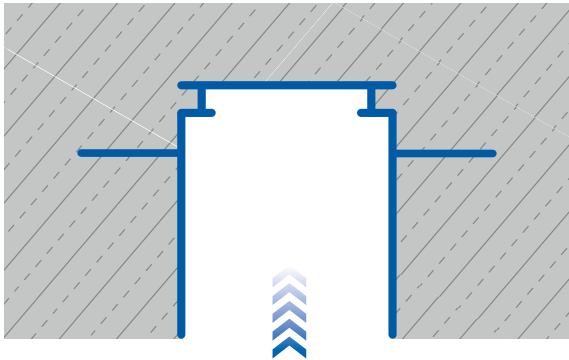

LIPOD 26×24,5 mm

PRIMO 30

Konverter extern

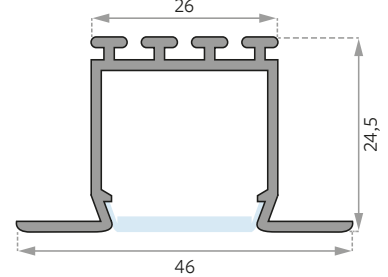
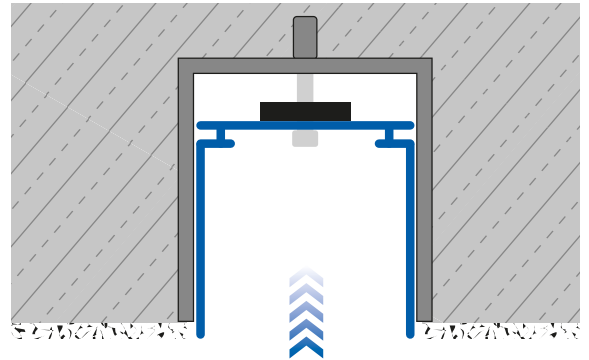

LARKO 26-46×24,5 mm

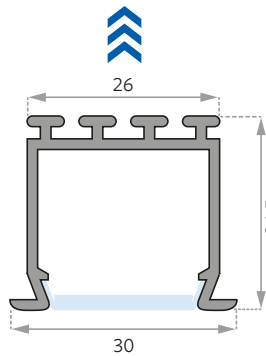

LOKOM 26-30×24,5 mm

EINLEGE- UND GRUNDPROFILE | FÜR SICHTBETON/WEISSPUTZ (FIXLÄNGEN)

LAGO600-1800

30 × 35 mm

inkl. Konverterbox

Fixlängen pro Stange:

621, 921, 1221, 1521, 1821 mm

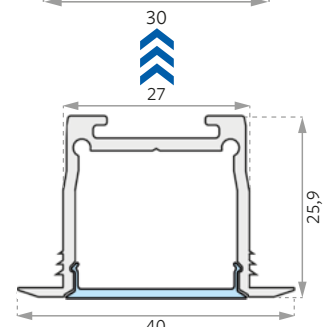
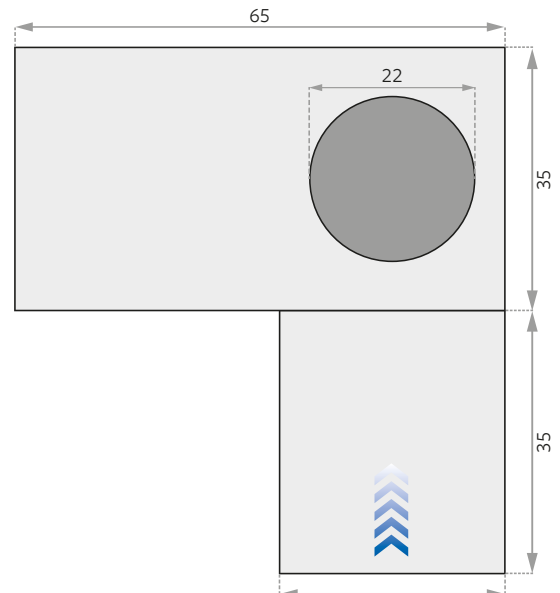

MEDIUM WING 40-27×25,9 mm

EINLEGE- UND GRUNDPROFILE | HOHLDECKEN/GIPSEINBAU

TEKNIK-ZM
30-66x28,5 mm

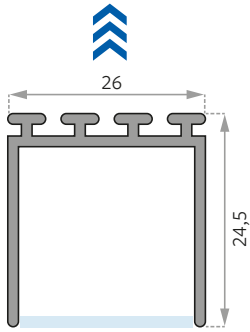
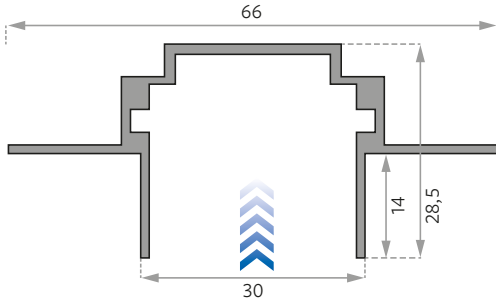

LIPOD 26x24,5 mm

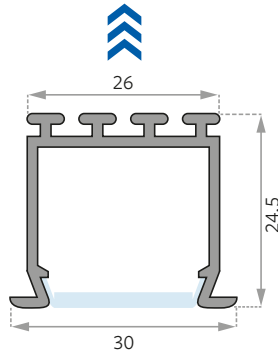

LOKOM 26-30x24,5 mm

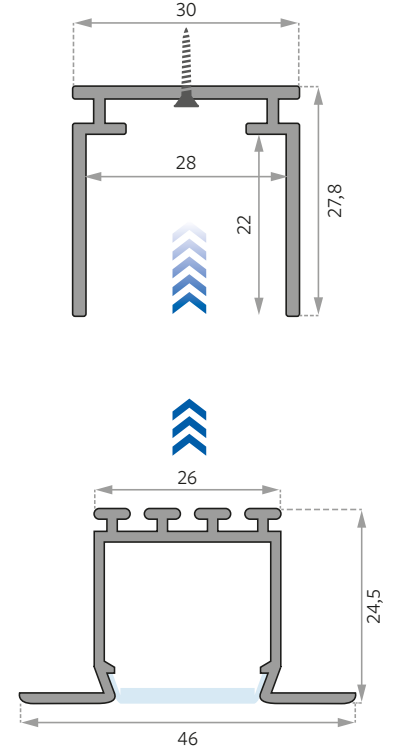

LARKO 26-46x24,5 mm

EINLEGE- UND GRUNDPROFILE | GIPSEINBAU

LP-U2020
20x20 mm

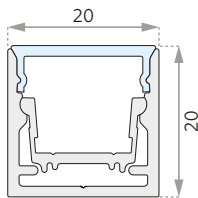

LP-U3030
30x30 mm

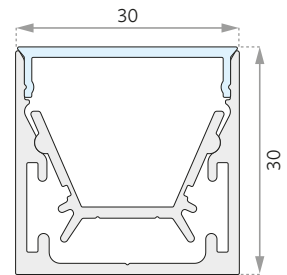

MLT

Moderne Licht-Technik AG

Tägerhardstrasse 110

5430 Wettingen

056 427 02 50

info@mlt-licht.ch

mlt-licht.ch

*Gutes Licht
ist kein Zufall*