

## ALUMINIUM-MONTAGEPROFILE | AUF EINEN BLICK

### GARLIANO

19 × 22 mm

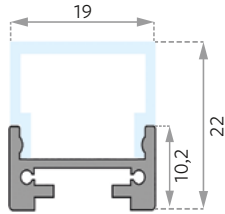

### GARGANO

17,92 × 15,5 mm

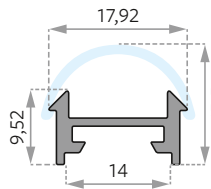

### LP-U2020

20 × 20 mm

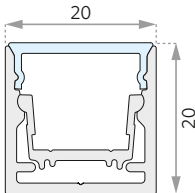

### SMALL WING

24,9–18,8 × 13 mm

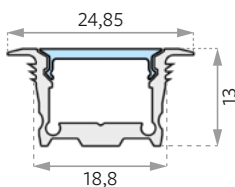

### SMALL CORNER

22,8 × 22,8 mm

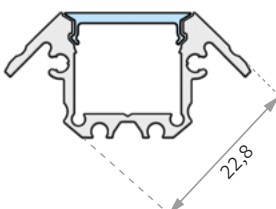

### BARDOLINO H-PROFIL

18,4 × 30 mm

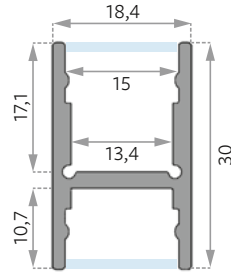

### BARDOLINO DUO

16,6 × 51 mm

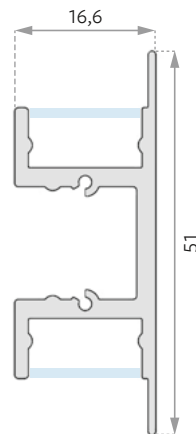

### MEDIUM SQUARE

27 × 23,8 mm

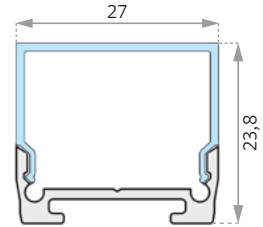

### MEDIUM FLAT

27 × 10,2 mm

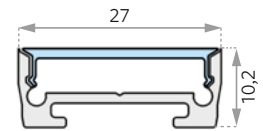

### MEDIUM U

27 × 25,9 mm

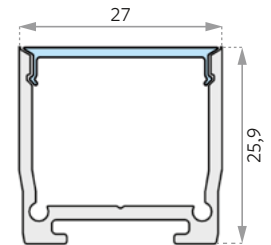

### MEDIUM WING

40–27 × 25,9 mm

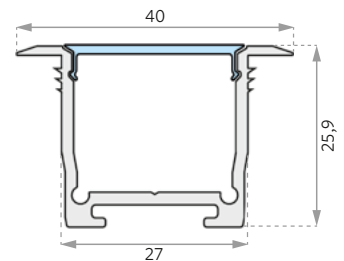

### SMALL FLAT

17,3 × 9,6 mm

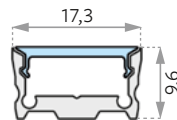

### SMALL U

17,3 × 16 mm

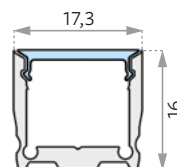

## ALUMINIUM-MONTAGEPROFILE | AUF EINEN BLICK

LP-U3030  
30×30 mm

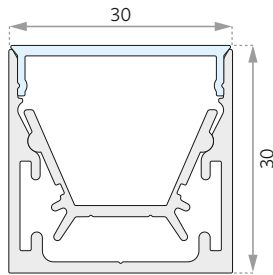

ANGOLO ECK-PROFIL  
30×30 mm

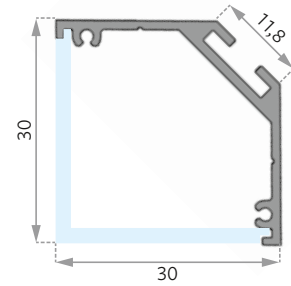

EPIC III  
39,5×62,8 mm

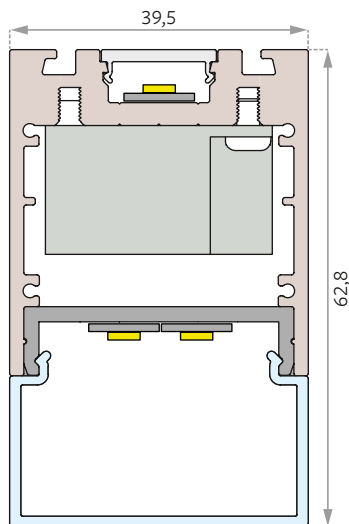

EPIC IV  
39,5×43,0 mm

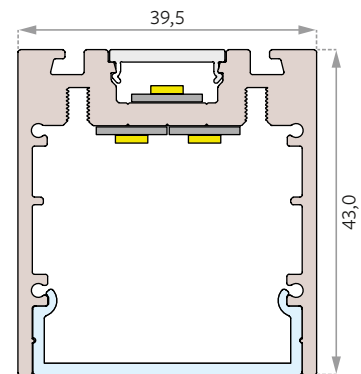

EPIC I  
39,5×44,15 mm

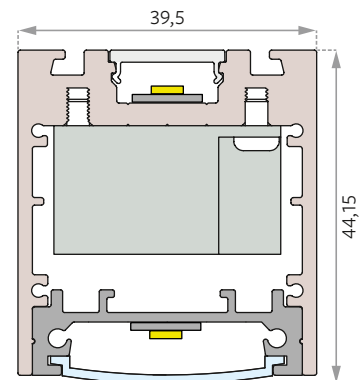

## EINLEGE- UND GRUNDPROFILE | FÜR SICHTBETON/WEISSPUTZ (VARIABLE LÄNGEN)

VISTO 30

Konverter extern

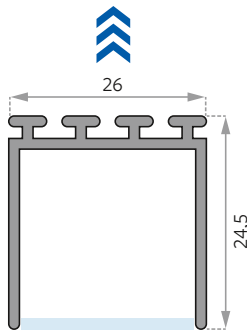
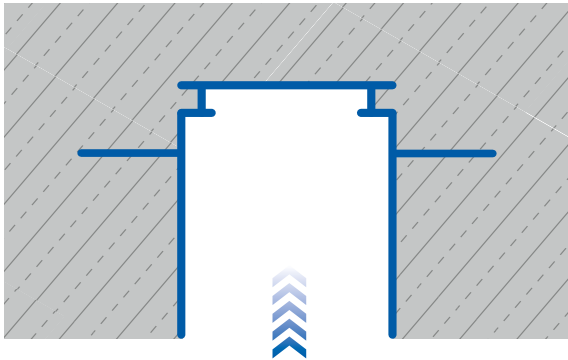

**LIPOD** 26×24,5 mm

PRIMO 30

Konverter extern

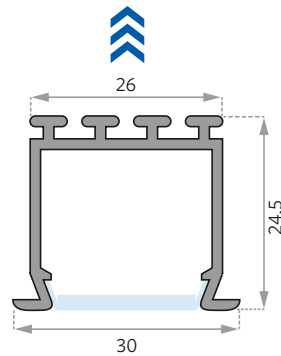
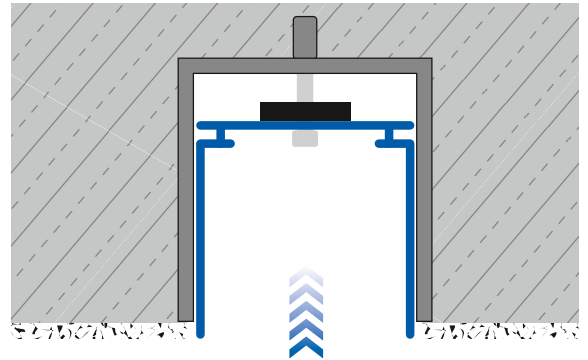

**LOKOM** 26-30×24,5 mm

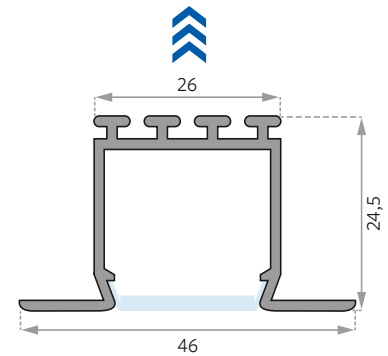

**LARKO** 26-46×24,5 mm

## EINLEGE- UND GRUNDPROFILE | FÜR SICHTBETON/WEISSPUTZ (FIXLÄNGEN)

LAGO600-1800

30 × 35 mm

inkl. Konverterbox

Fixlängen pro Stange:

621, 921, 1221, 1521, 1821 mm

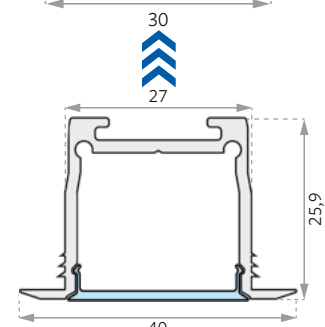
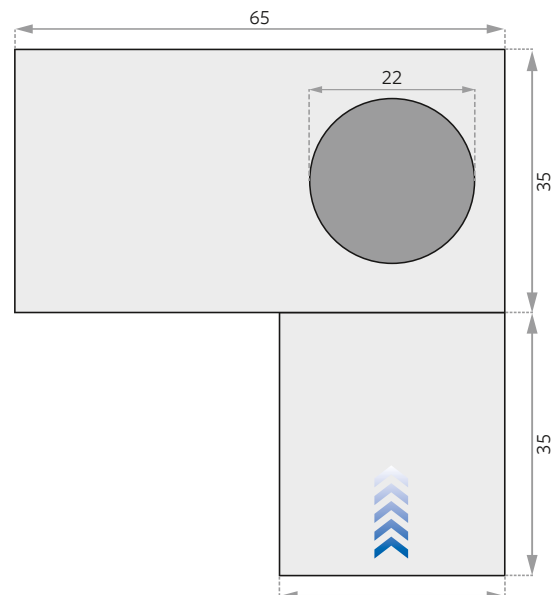

**MEDIUM WING** 40-27×25,9 mm

## EINLEGE- UND GRUNDPROFILE | HOHLDECKEN/GIPSEINBAU

### TEKNIK-ZM

30-66×28,5 mm

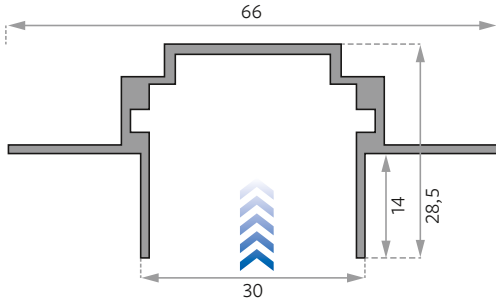

### TEKOR

30×27,8 mm

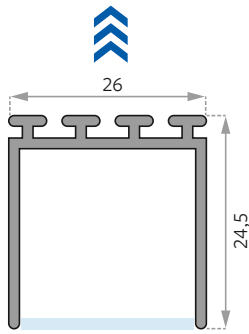
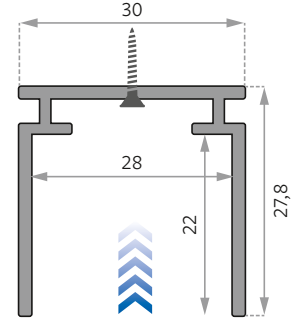

LIPOD 26×24,5 mm

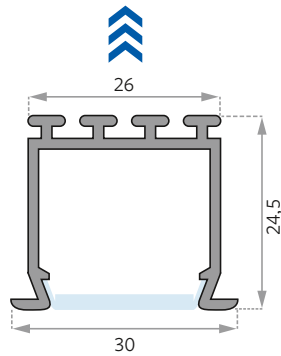

LOKOM 26-30×24,5 mm

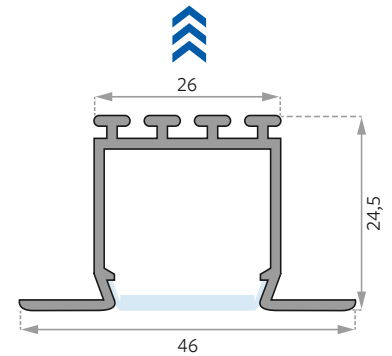

LARKO 26-46×24,5 mm

## EINLEGE- UND GRUNDPROFILE | GIPSEINBAU

### LP-U2020

20×20 mm

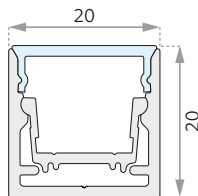

### LP-U3030

30×30 mm

