



p.thirty



p.thirty

**SMALL BUT
POWERFUL**

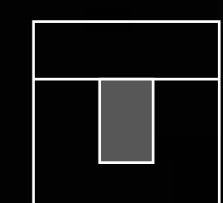

Surface

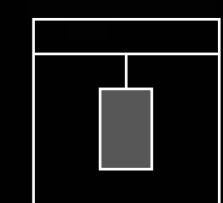

Pendant

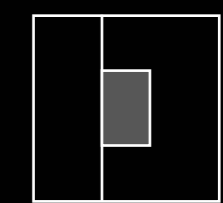

Wall

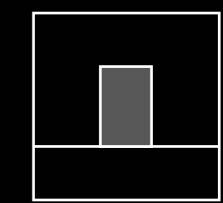

Recessed

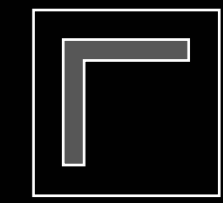

Systems

NEUE OPTIKEN FÜR P.THIRTY



EINE KLEINE PROFILLEUCHE SCHREIBT GROSSE GESCHICHTEN.

KLEIN, ABER KRAFTVOLL

p.thirty ist das kleinste der PLANLICHT Profileuchten und überzeugt mit einem minimalistischen Design und großer Variabilität. Eine herausragende Leistung, hoher Sehkomfort und integrierte Betriebsgeräte sind selbstverständlich.

SMALL PROFILE LUMINAIRE WRITES HUGE STORIES.

SMALL BUT POWERFUL

p.thirty is the smallest of the PLANLICHT profile luminaires and impresses with a minimalistic design and great variability. Great performance, high eye comfort and an integrated driver go without saying.

JET-BLACK-MIKROPRISMATISCH

Der spezielle Diffusor in der Farbe Jet Black Mikroprisma verleiht der Leuchte einen außergewöhnlichen Look.

JET BLACK MICROPRISM

The special diffuser colour Jet Black Mikroprisma provides an extraordinary look.



P.THIRTY OPTO-BALANCE DARKLIGHT® | KOMPROMISSLOS PUNKTGENAU

p.thirty Opto-Balance Darklight® besticht durch die zonierte Lichtausgabe, ihre extrem kleinen Abmessungen und mit integriertem Betriebsgerät trotz der ausgeklügelten Lichtlenkungstechnologie.

Durch die Bündelung des Raumlichtes wird die zu beleuchtende Fläche optimal erhellt und das Licht landet exakt dort, wo es gewünscht ist. Kompromisslos punktgenau.

Zudem weist die neue OBD-Variante in allen Montagearten auch

rein direkt strahlend und in jeglicher Bestromung einen UGR-Wert unter 16 auf und sorgt somit für normkonformen Sehkomfort. In der Variante als Hängeleuchte mit direkt/indirekter Lichtabgabe liegt der Blendwert sogar unter 6 – einem sagenhaft niedrigen Wert, der selbst in den gängigsten Beleuchtungsfibeln nicht abgebildet wird.

Die Spezialausführung „office special“ überzeugt zusätzlich durch die Reduktion der Wartungs- und Betriebskosten.

P.THIRTY OPTO-BALANCE DARKLIGHT® | UNCOMPROMISINGLY SPOT-ON

p.thirty Opto-Balance Darklight® (OBD) impresses with its zoned light output, its extremely small dimensions and with an integrated driver despite its sophisticated light focusing technology. By concentrating the light output, the respective workspace surface is optimally illuminated and no light is wasted, as it arrives exactly where it is needed. Uncompromisingly precise and spot-on.

In addition, the new OBD version has an UGR value of less than 16 in all mounting types, all output versions and even with solely direct light distribution, thus ensuring visual comfort according to unified standards. As a pendant luminaire with direct/indirect light output, the glare value is even below 6 – a value so low that it is not even mentioned in most literature about lighting design.

VORTEILE

- Optimal ausbalanciertes Licht
- Innovative Lichttechnologie
- Maximaler Sehkomfort
- Minimalistisches Design & Größe
- Trendige metallische Optikbeschichtungen

BENEFITS

- Optimally balanced light
- Innovative lighting technology
- Maximum visual comfort
- Minimalist design & size
- Trendy metallic reflector coatings



MINIMALISTISCHES PROFIL

Eine Profilbreite von nur 31 mm.

*Minimalistic profile
Profil minimaliste*



HOHE LICHTLEISTUNG

Grund- und Arbeitsplatzbeleuchtung

*High performance
Haute puissance lumineuse*



HOHER SEHKOMFORT

Homogene Opal-Diffusoren und blendfreie Mikroprismen.

*Eye comfort
Confort visuel élevé*



INTEGRIERTES VORSCHALTGERÄT

Triber immer vollständig im Profilgehäuse integriert.

*Driver integrated
Ballast intégré*

SPRITZWASSERGESCHÜTZT

Erhältlich in der IP44-Version für Badezimmer.

*Splash water proof
Protégée contre les projections d'eau*



MODULARE SYSTEMLÖSUNG

Verbindung von Modulen, um individuelle Beleuchtungslösungen zu schaffen.

*Modular system
Solution système modulaire*



BELEUCHTETE ENDKAPPEN

U-förmige Diffusoren können mit beleuchteten Endkappen ausgerüstet werden.

*Illuminated end caps
Embouts éclairés*



RUNDE VARIANTE

Auch als Ringleuchten-Pendant verfügbar: sinus p.thirty.

*Round variant
Variante ronde*



VERSCHIEDENE DIFFUSOREN

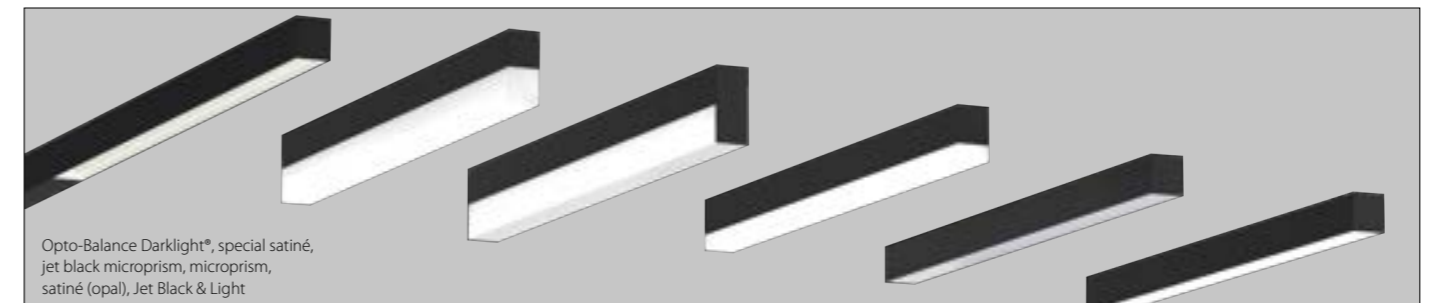

SPEZIELLE ENDKAPPEN

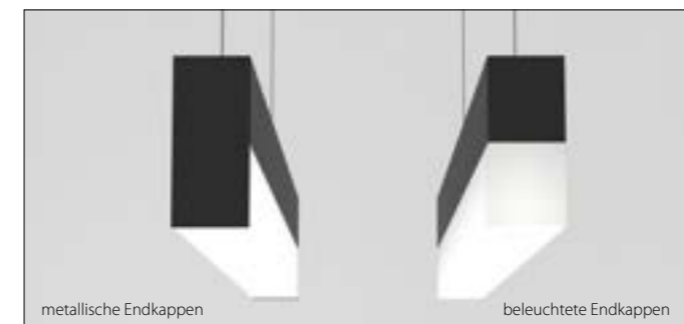

OPTO-BALANCE DARKLIGHT® (INKL. OFFICE SPECIAL VARIANTE)

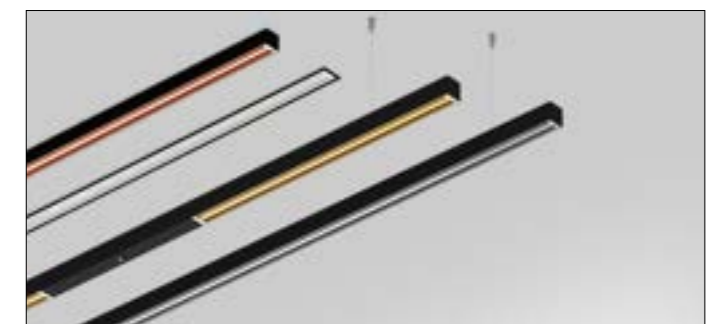

P.THIRTY - SMALL BUT POWERFUL

Inspiration

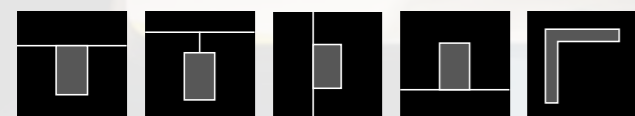

**P.THIRTY
PROJEKTE**



INSPIRATION

Produkt: p.thirty



INSPIRATION

Produkt: p.thirty



RATSSAAL WEINSBERG | DEUTSCHLAND

Produkte: p.thirty, pure 3
Foto: © Fotografie Dietmar Strauß, Besigheim | Architekten: MATTES RIGLEWSKI WAHL Architekten

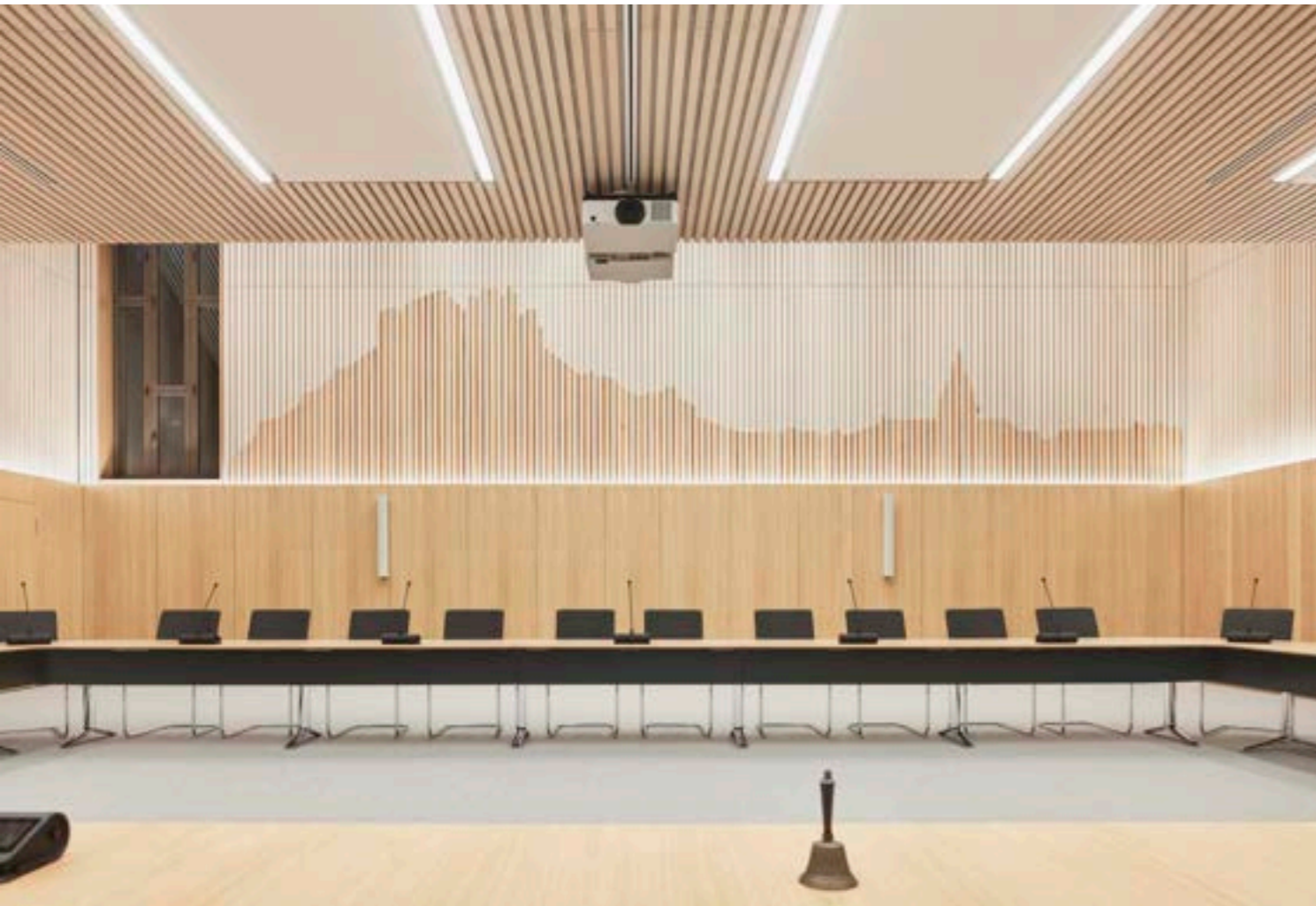

INSPIRATION

Produkt: p.thirty

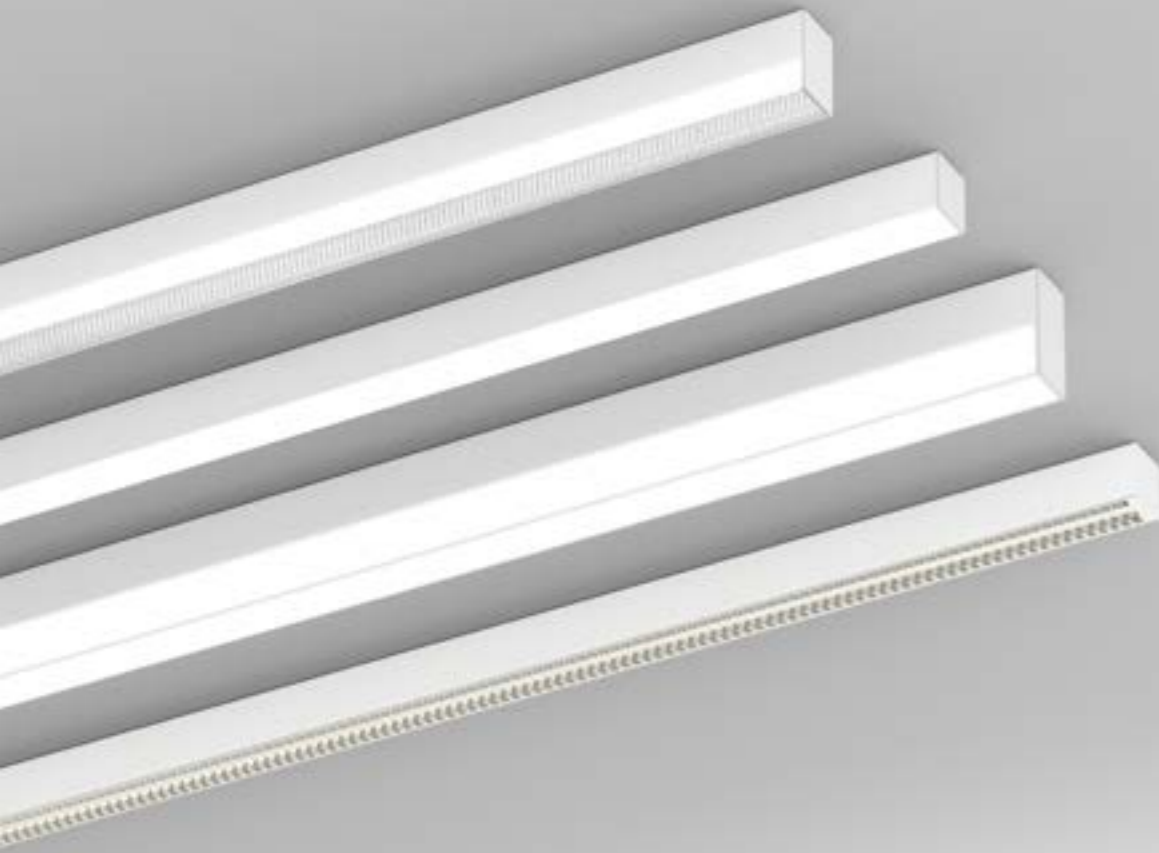

1 SIZE

557 mm (non-dim)	055
827 mm	082
1187 mm	118
1457 mm	145
2899 mm	289
3531 mm	353
4341 mm	434

2 COLOUR

	silver	9006
	white	9016
	black	9005
	RAL of your choice	

3 LED

	2700 K, CRI > 90	927
	3000 K, CRI > 90	930
	4000 K, CRI > 90	940
	4000 K, CRI > 80	840

4 OUTPUT/CONTROL

DIFFUSER	
	low output non-dim
	low output DALI
	high output non dim (557 mm)
	high output DALI
OBD (Opto-Balance Darklight®)	
	high output non dim
	high output DALI
	very high output non-dim (not 827mm)
	very high output DALI (not 827mm)

5 OPTIC

	satiné	S
	jet black & light	J NEW
	microprism*	M
	U-shaped satiné, 15 mm	U
	U-shaped satiné, 34 mm	Q
	U-shaped jet black microprism, 15 mm*	V
	Opto-Balance Darklight® BAP high-gloss black chrome*	Z NEW
	Opto-Balance Darklight® BAP high-gloss copper*	K NEW
	Opto-Balance Darklight® BAP high-gloss gold*	G NEW
	Opto-Balance Darklight® BAP high-gloss silver*	B NEW

* UGR-optimised, configure online

P30A 1-2 C1 3 4 5

P30A082-9016C1930H35 Surface, 827 mm, white, IP20, direct, 3000 K, CRI > 90, high output DALI, satiné (order sample)

► Configure online on KATALOG.PLANLICHT.COM

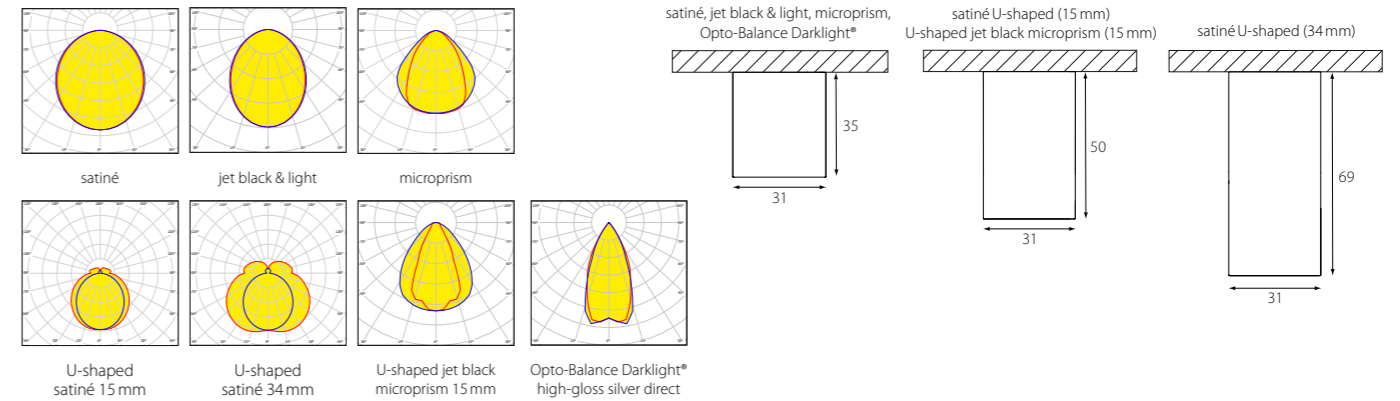

LUMINOUS FLUX (LM) / SYSTEM POWER (W), 4000 K, CRI > 80

4000 K satiné CRI > 80	low output	high output	very high output	
557 mm	930 lm / 8 W	1324 lm / 11,5 W		0,6 kg
827 mm	1388 lm / 10,5 W	1981 lm / 15,5 W		0,8 kg
1187 mm	1999 lm / 14,5 W	2855 lm / 21 W		1,1 kg
1457 mm	2457 lm / 17 W	3512 lm / 25 W		1,3 kg
2899 mm	4895 lm / 34 W	7008 lm / 50 W		2,5 kg
3531 mm	5961 lm / 43 W	8537 lm / 62 W		3,0 kg
4341 mm	7331 lm / 51 W	10503 lm / 74 W		3,7 kg

(based on optic Q)

COMPARE COVER 1457 MM, 4000 K, CRI > 80

	low output	high output	very high output
satiné	2457 lm	3512 lm	
jet black & light	506 lm	723 lm	
microprism*	2534 lm	3624 lm	
U-shaped satiné (15 mm)	2588 lm	3710 lm	
U-shaped satiné (34 mm)	2724 lm	3903 lm	
U-shaped jet black microprism (15 mm)	1419 lm	2020 lm	
Opto-Balance Darklight® high-gloss silver		1941 lm	3836 lm

COMPARE LIGHT COLOUR 1457 MM, SATINÉ

4000 K, CRI > 80	3512 lm
2700 K, CRI > 90	2637 lm
3000 K, CRI > 90	2769 lm
4000 K, CRI > 90	2862 lm

*Der angegebene Lichtstrom bezieht sich auf die Leuchte mit klarer mikroprismatischer Abdeckung. Die Leuchte wird mit satinierter Folie zur Erhöhung der Homogenität geliefert (Direkt strahlend: -13,9%, direkt/indirekt strahlend: -6,9% Lichtstrom). Die angegebenen Lichtstromwerte (lm) beziehen sich auf Leuchten mit einem weißen Gehäuse (RAL 9016). Je nach Gehäusefarbe und Länge reduzieren sich diese entsprechend (bezieht sich nur auf U-förmige Abdeckungen).

The indicated luminous flux corresponds to the luminaire with a clear microprismatic diffuser. The luminaire is delivered with a satinized-foil for increased homogeneity (direct: -13,9%, direct-indirect: -6,9% luminous flux).

All figures of luminous flux (lm) are for fixtures with white housing (RAL 9016). Depending on the housing colour and length, the luminous flux is reduced accordingly. This only applies to U-shaped optics.

Le flux lumineux indiqué correspond au luminaire avec diffuseur microprismatique transparent. Le luminaire est livré avec un film satiné pour optimiser l'homogénéité (direct: -13,9%, direct-indirect: -6,9% sur le flux lumineux).

Les valeurs de flux lumineux (lm) indiquées se réfèrent aux luminaires à corps blanc (RAL 9016). En fonction de la couleur du corps et de la longueur, celles-ci sont réduites en conséquence (se réfère uniquement aux caches en forme de U).



Down to UGR ≤ 16 | up to 167 lm/W | up to 2958 lm/m | IEC 62471: Blue light hazard: RG 0 | DALI push switchDIM

P.THIRTY PROFILE SYSTEM



p.thirty IP44

Aufbauleuchte
Surface luminaire
Luminaires en saillie

P.THIRTY | SURFACE

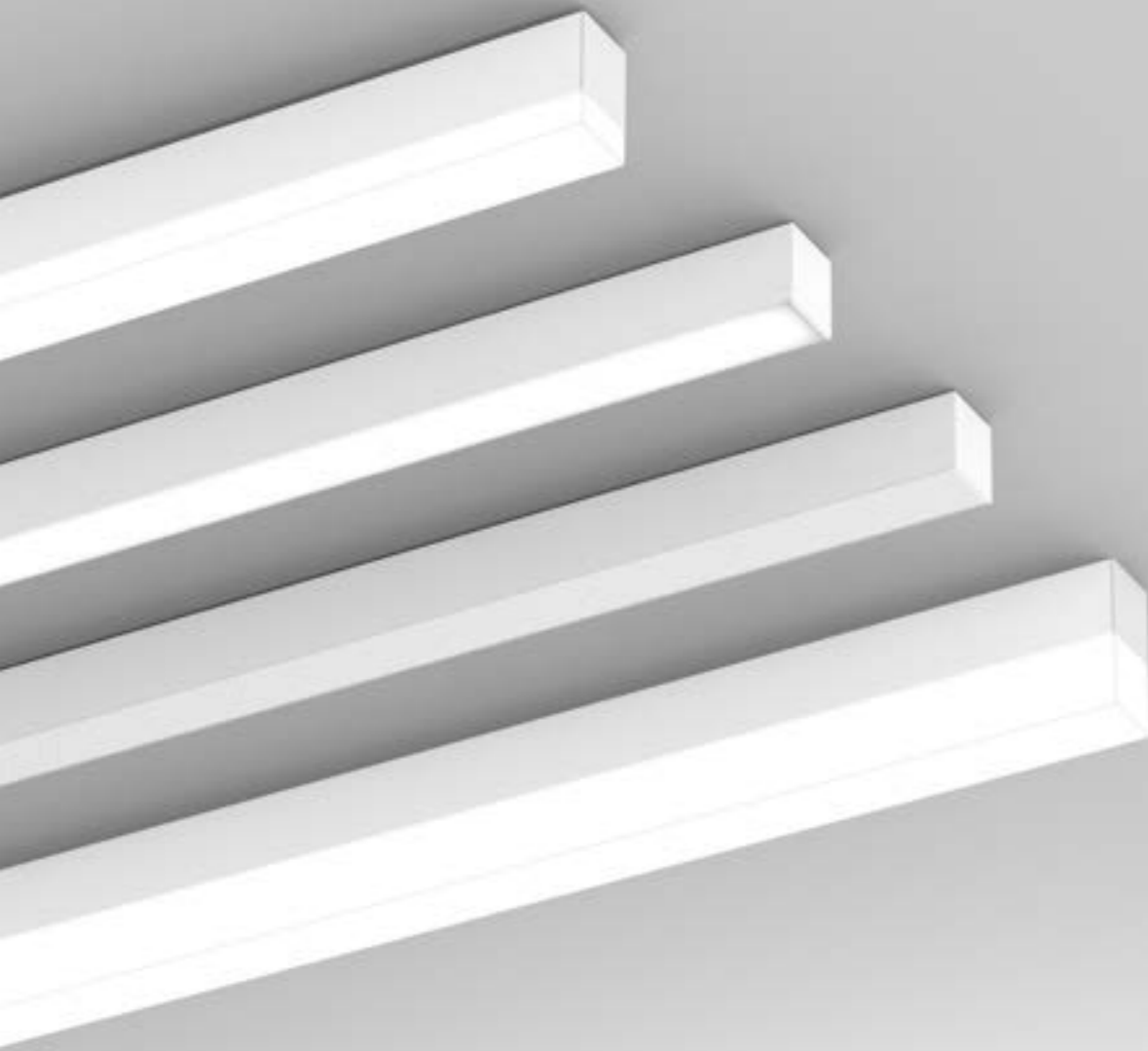

1 SIZE

557 mm (non-dim)	055
827 mm	082
1187 mm	118
1457 mm	145

2 COLOUR

	silver	9006
	white	9016
	black	9005
	RAL of your choice	

3 LED

	2700 K, CRI > 90	927
	3000 K, CRI > 90	930
	4000 K, CRI > 90	940
	4000 K, CRI > 80	840

4 OUTPUT / CONTROL

	low output non-dim	L1
	low output DALI	L3
	high output DALI	H3
	high output non dim (557 mm)	H1

5 OPTIC

	satiné	S
	jet black & light	J NEW
	microprism (some versions UGR < 19)	M
	U-shaped satiné, 15 mm	U
	U-shaped satiné, 34 mm	Q

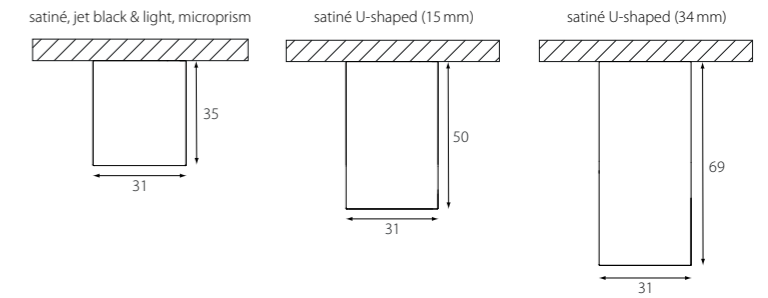
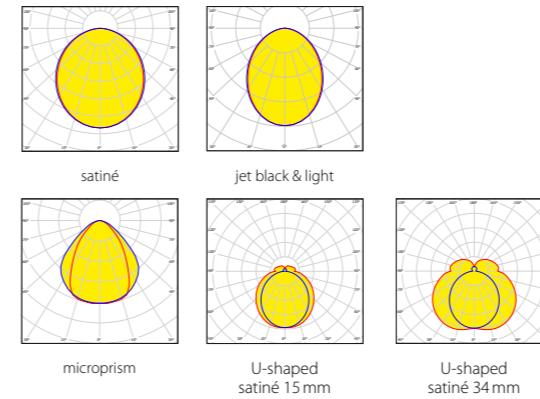

LUMINOUS FLUX (LM) / SYSTEM POWER (W), 4000 K, CRI > 80

4000 K satiné CRI > 80	low output	high output	
557 mm	930 lm / 8 W	1324 lm / 11,5 W	0,6 kg
827 mm	1388 lm / 10,5 W	1981 lm / 15,5 W	0,8 kg
1187 mm	1999 lm / 14,5 W	2855 lm / 21 W	1,1 kg
1457 mm	2457 lm / 17 W	3512 lm / 25 W	1,3 kg

(based on optic Q)

COMPARE COVER 1457 MM, 4000 K, CRI > 80

	low output	high output
satiné	2457 lm	3512 lm
jet black & light	506 lm	723 lm
microprism*	2534 lm	3624 lm
U-shaped satiné (15 mm)	2588 lm	3710 lm
U-shaped satiné (34 mm)	2724 lm	3903 lm

COMPARE LIGHT COLOUR 1457 MM, SATINÉ

4000 K, CRI > 80	3512 lm
2700 K, CRI > 90	2637 lm
3000 K, CRI > 90	2769 lm
4000 K, CRI > 90	2862 lm

*Der angegebene Lichtstrom bezieht sich auf die Leuchte mit klarer mikroprismatischer Abdeckung. Die Leuchte wird mit satinierter Folie zur Erhöhung der Homogenität geliefert (Direkt strahlend: -13,9% , direkt/indirekt strahlend: -6,9% Lichtstrom). Die angegebenen Lichtstromwerte (lm) beziehen sich auf Leuchten mit einem weißen Gehäuse (RAL 9016). Je nach Gehäusefarbe und Länge reduzieren sich diese entsprechend (bezieht sich nur auf U-förmige Abdeckungen). The indicated luminous flux corresponds to the luminaire with a clear microprismatic diffuser. The luminaire is delivered with a satinized-foil for increased homogeneity (direct: -13,9%, direct-indirect: -6,9% luminous flux). All figures of luminous flux (lm) are for fixtures with white housing (RAL 9016). Depending on the housing colour and length, the luminous flux is reduced accordingly. This only applies to U-shaped optics. Le flux lumineux indiqué correspond au luminaire avec diffuseur microprismatique transparent. Le luminaire est livré avec un film satiné pour optimiser l'homogénéité (direct: -13,9 %, direct-indirect: -6,9 % sur le flux lumineux). Les valeurs de flux lumineux (lm) indiquées se réfèrent aux luminaires à corps blanc (RAL 9016). En fonction de la couleur du corps et de la longueur, celles-ci sont réduites en conséquence (se réfère uniquement aux caches en forme de U).

P30A 1-2 P1 3 4 5

P30A082-9016P1930H3S 827 mm, white, IP44, direct, 3000 K, CRI > 90, high output DALI, satiné (order sample)

► [Configure online on KATALOG.PLANLICHT.COM](#)



Down to UGR ≤ 16 | up to 160 lm/W | up to 2692 lm/m | IEC 62471: Blue light hazard: RG 0 | DALI push switchDIM

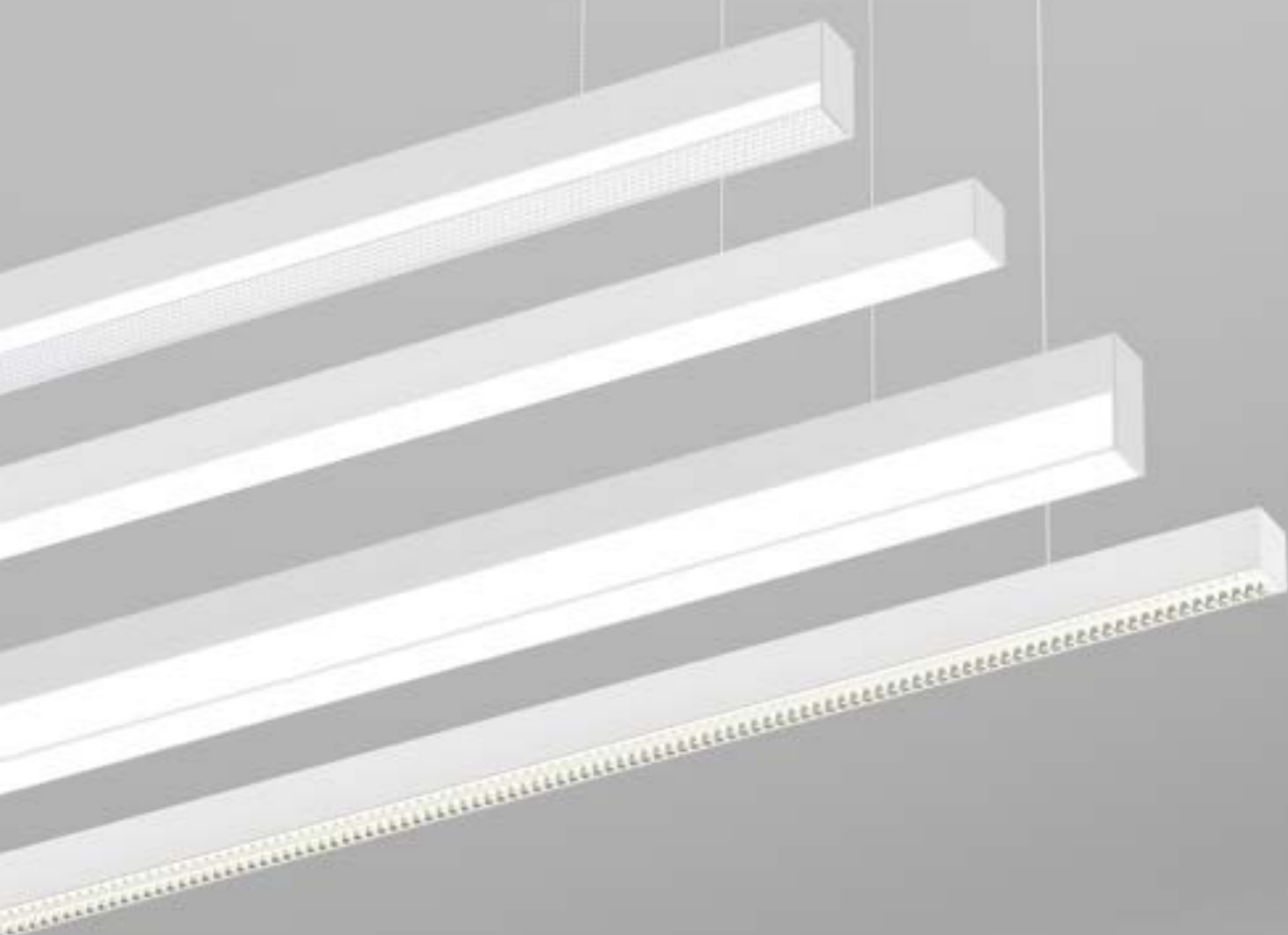

1 SIZE		2 COLOUR		3 DIRECT / INDIRECT	
1187 mm	118	black	9005	direct	1
1457 mm	145	silver	9006	direct/indirect	2
2899 mm	289	white	9016		
3531 mm	353	RAL of your choice			
4341 mm	434				
4 LED		5 OUTPUT / CONTROL		6 OPTIC	
2700 K, CRI > 90	927	DIFFUSER		satiné	S
3000 K, CRI > 90	930	low output non-dim	L1	jet black & light	J NEW
4000 K, CRI > 90	940	low output DALI	L3	microprism*	M
4000 K, CRI > 80	840	high output DALI	H3	U-shaped satiné, 15 mm	U
		OBD (Opto-Balance Darklight®)		U-shaped satiné, 34 mm	Q
		high output non dim	H1	U-shaped jet black microprism, 15 mm*	V
		high output DALI	H3	Opto-Balance Darklight® BAP high-gloss black chrome*	Z NEW
		very high output non-dim (not direct/indirect)	V1	Opto-Balance Darklight® BAP high-gloss copper*	K NEW
		very high output DALI (not direct/indirect)	V3	Opto-Balance Darklight® BAP high-gloss gold*	G NEW
				Opto-Balance Darklight® BAP high-gloss silver*	B NEW

* UGR-optimised, configure online

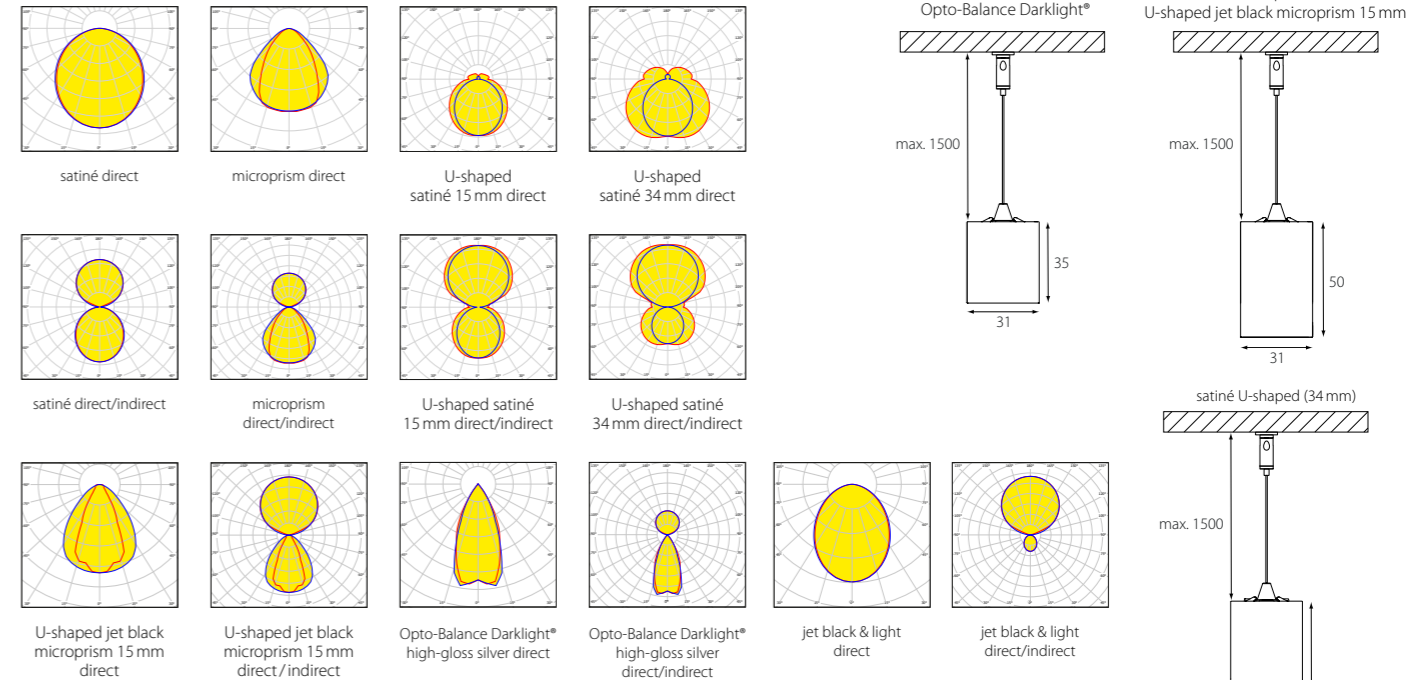

LUMINOUS FLUX (LM) / SYSTEM POWER (W), 4000 K, CRI > 80

4000 K satiné	direct			direct / indirect		weight
	low output	high output	very high output	low output	high output	
1187 mm	1999 lm / 14,5 W	2855 lm / 21 W		3755 lm / 25 W	5329 lm / 36 W	1,1 kg
1457 mm	2457 lm / 17 W	3512 lm / 25 W		4802 lm / 31 W	6818 lm / 44 W	1,3 kg
2899 mm	4895 lm / 34 W	7008 lm / 50 W		9992 lm / 63 W	14200 lm / 91 W	2,5 kg
3531 mm	5961 lm / 43 W	8537 lm / 62 W		12242 lm / 77 W	17398 lm / 112 W	3,0 kg
4341 mm	7331 lm / 51 W	10503 lm / 74 W		14992 lm / 95 W	21315 lm / 137 W	3,7 kg

(based on optic Q)

COMPARE COVER 1457 MM, 4000 K, CRI > 80

	direct	direct / indirect
satiné	2457 lm	4802 lm
jet black & light	506 lm	4879 lm
microprism*	2534 lm	4933 lm
U-shaped satiné (15 mm)	2588 lm	5069 lm
U-shaped satiné (34 mm)	2724 lm	3764 lm
U-shaped jet black microprism	1419 lm	2851 lm
Opto-Balance Darklight* high-gloss silver	1941 lm	5102 lm

COMPARE LIGHT COLOUR 1457 MM, SATINÉ

4000 K, CRI > 80	3512 lm
2700 K, CRI > 90	2637 lm
3000 K, CRI > 90	2769 lm
4000 K, CRI > 90	2862 lm

OPTIONAL ACCESSORY

PROTECTIVE COVER (INDIRECT)

P30-DIF-ID
LED-board cover, optional, reduces lumen output (max. 3,95%), sold by the metre

P.THIRTY PROFILE SYSTEM



*Der angegebene Lichtstrom bezieht sich auf die Leuchte mit klarer mikroprismatischer Abdeckung. Die Leuchte wird mit satinierter Folie zur Erhöhung der Homogenität geliefert (Direkt strahlend: -13,9%, direkt/indirekt strahlend: -6,9% Lichtstrom). Die angegebenen Lichtstromwerte (lm) beziehen sich auf Leuchten mit einem weißen Gehäuse (RAL 9016). Je nach Gehäusefarbe und Länge reduzieren sich diese entsprechend (bezieht sich nur auf U-förmige Abdeckungen).
The indicated luminous flux corresponds to the luminaire with a clear microprismatic diffuser. The luminaire is delivered with a satinized foil for increased homogeneity (direct -13,9%, direct/indirect -6,9% luminous flux). All figures of luminous flux (lm) are for fixtures with white housing (RAL 9016). Depending on the housing colour and length, the luminous flux is reduced accordingly. This only applies to U-shaped optics.
Le flux lumineux indiqué correspond au luminaire avec diffuseur microprismatique transparent. Le luminaire est livré avec un film satiné pour optimiser l'homogénéité (direct: -13,9%, direct-indirect: -6,9% sur le flux lumineux). Les valeurs de flux lumineux (lm) indiquées se réfèrent aux luminaires à corps blanc (RAL 9016). En fonction de la couleur du corps et de la longueur, celles-ci sont réduites en conséquence (se réfère uniquement aux caches en forme de U).

NEW p.thirty office special

Hängeleuchte
Pendant luminaire
Suspension

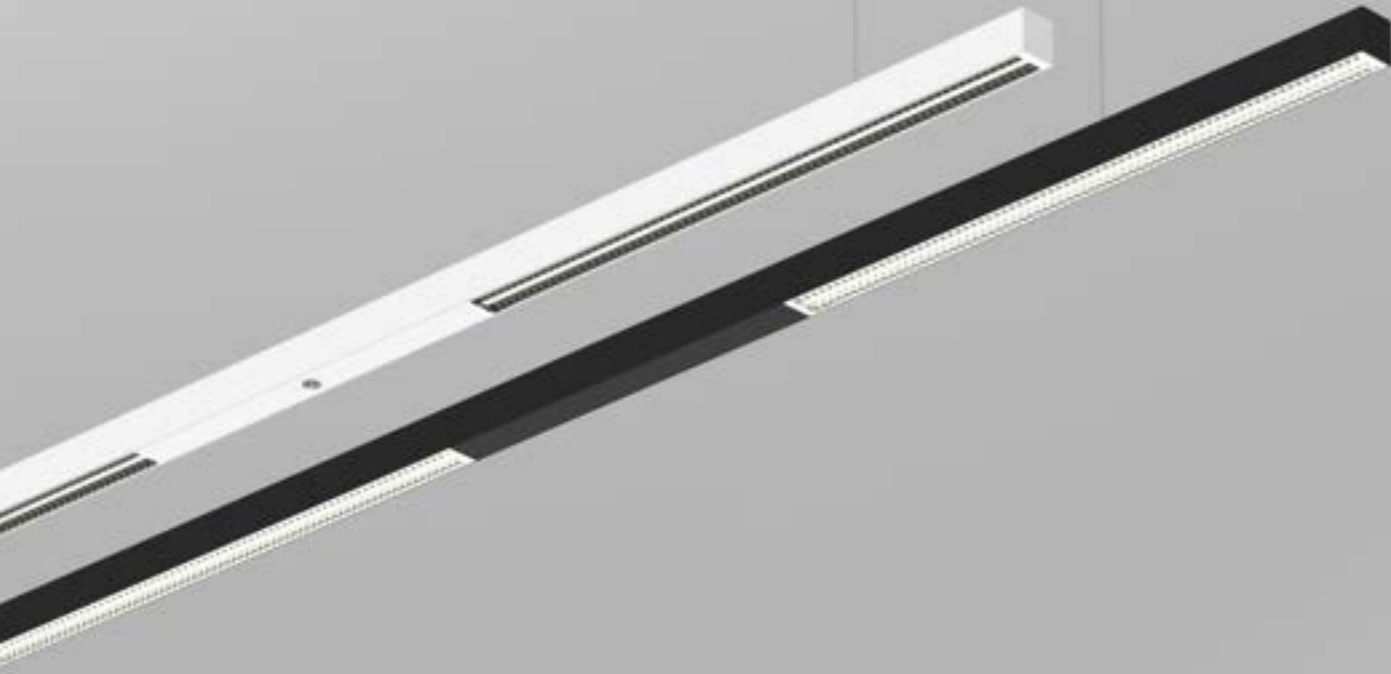

P.THIRTY OFFICE SPECIAL | PENDANT

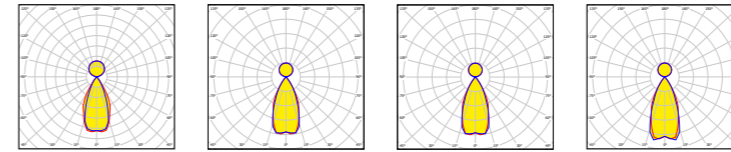

Opto-Balance Darklight® BAP high-gloss black chrome
Opto-Balance Darklight® BAP high-gloss copper
Opto-Balance Darklight® BAP high-gloss gold
Opto-Balance Darklight® BAP high-gloss silver

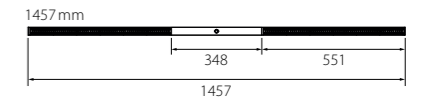
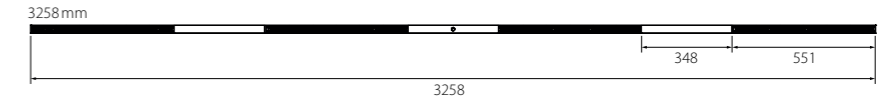
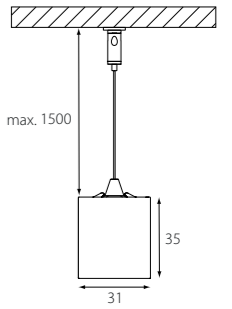

LUMINOUS FLUX (LM)/SYSTEM POWER (W), 4000 K, CRI > 0, HIGH-GLOSS SILVER

Length	very high output	Weight
1457 mm	5565 lm / 52 W	1,7 kg
3258 mm	10988 lm / 105 W	3,4 kg

COMPARE LOUVRES 1457 MM

Opto-Balance Darklight® BAP high-gloss black chrome	4817 lm
Opto-Balance Darklight® BAP high-gloss copper	5371 lm
Opto-Balance Darklight® BAP high-gloss gold	5407 lm
Opto-Balance Darklight® BAP high-gloss silver	5565 lm

P.THIRTY OFFICE SPECIAL 3258 MM

ideal for table size 3600x900 mm

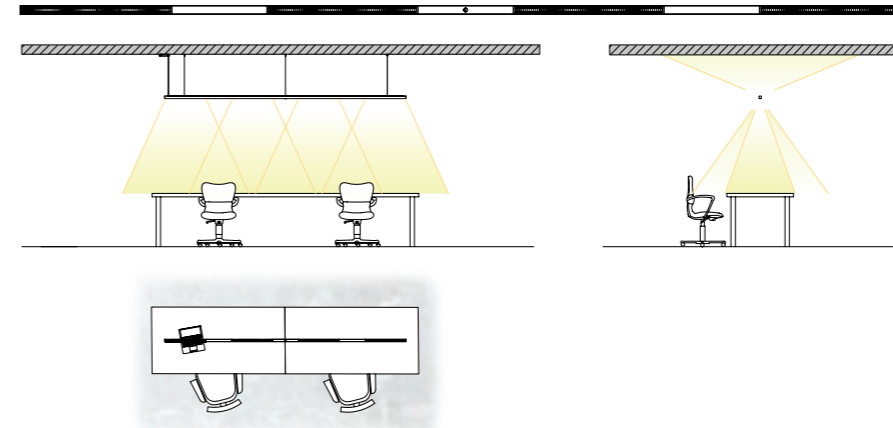

P.THIRTY OFFICE SPECIAL 1457 MM

ideal for table size 1800x900 mm

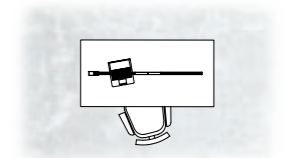
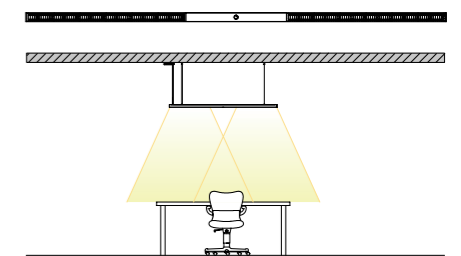

1 SIZE

1457 mm	14X
3258 mm	32X

2 COLOUR

	black	9005
	silver	9006
	white	9016
	RAL of your choice	

3 LED

	2700 K, CRI > 90	927
	3000 K, CRI > 90	930
	4000 K, CRI > 90	940
	4000 K, CRI > 80	840

4 CONTROL

	non-dim	1
	DALI	3
	Sensor DALI	7

5 OPTIC

	Opto-Balance Darklight® BAP high-gloss black chrome*	Z	NEW
	Opto-Balance Darklight® BAP high-gloss copper*	K	NEW
	Opto-Balance Darklight® BAP high-gloss gold*	G	NEW
	Opto-Balance Darklight® BAP high-gloss silver*	B	NEW

* UGR-optimised, configure online

P30H 1-2 C2 3 V 4 5

P30H14X-9016C2930V3B 1457 mm, white, IP20, direct & indirect, 3000 K, CRI > 90, very high output, DALI, Opto-Balance Darklight® high-gloss silver (order sample)

➔ [Configure online on KATALOG.PLANLICHT.COM](https://www.katalog.planlicht.com)



Down to UGR ≤ 16 | IEC 62471: Blue light hazard: RG 0 | DALI push switchDIM

NEW sinus p.thirty

Hängeleuchte
Pendant luminaire
Suspension

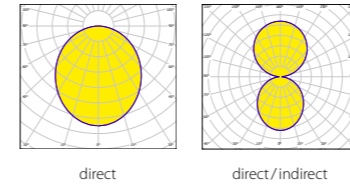

SINUS P.THIRTY | PENDANT

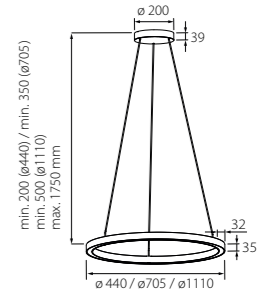

LUMINOUS FLUX (LM) / SYSTEM POWER (W)

4000K satiné	direct		direct/indirect		KG
	low output CRI > 80	high output CRI > 80	low output CRI > 80	high output CRI > 80	
ø 440 mm	1416 lm / 13,5 W	2083 lm / 21 W	3047 lm / 25 W	4471 lm / 38 W	2,0 kg
ø 705 mm	2360 lm / 21 W	3472 lm / 32 W	5079 lm / 42 W	7452 lm / 63 W	2,7 kg
ø 1110 mm	3776 lm / 34 W	5555 lm / 51 W	8126 lm / 66 W	11923 lm / 99 W	3,4 kg

(based on optic S, DALI)

COMPARE LIGHT COLOUR Ø 440 MM

2700 K, CRI > 90	1298 lm
3000 K, CRI > 90	1328 lm
4000 K, CRI > 90	1398 lm
4000 K, CRI > 80	1416 lm

1 SIZE	2 COLOUR	3 DIRECT / INDIRECT
ø 440 mm	044 silver	9006 direct 1
ø 705 mm	070 white	9016 direct/indirect 2
ø 1110 mm	111 black	9005
	RAL of your choice	
4 LED	5 OUTPUT / CONTROL	
2700 K, CRI > 90	927 low output non-dim L1	
3000 K, CRI > 90	930 low output DALI L3	
4000 K, CRI > 90	940 high output DALI H3	
4000 K, CRI > 80	840	

R30Z 1-2c345s

R30Z070-9016C1927L1S pendant, rope centrally merging, ø 705 mm, black, IP 20, direct, 2700 K, CRI > 90, low output, non-dim, satiné (order sample)

► [Configure online on KATALOG.PLANLICHT.COM](#)



up to 123 lm/W | IEC 62471: Blue light hazard: RG 0 | DALI switchDIM

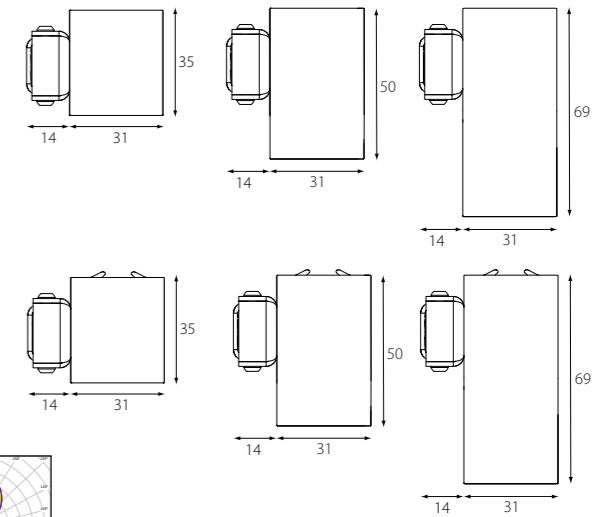
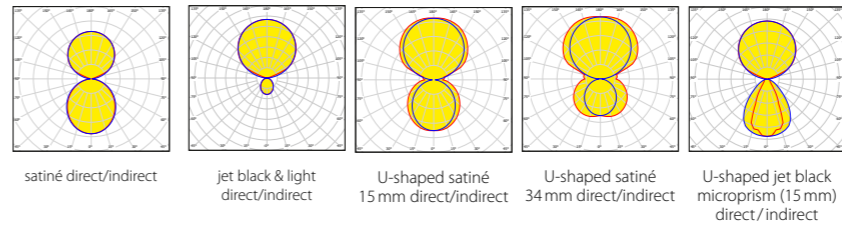
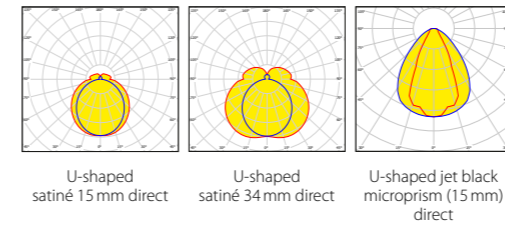
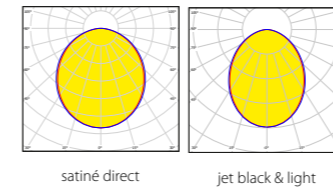
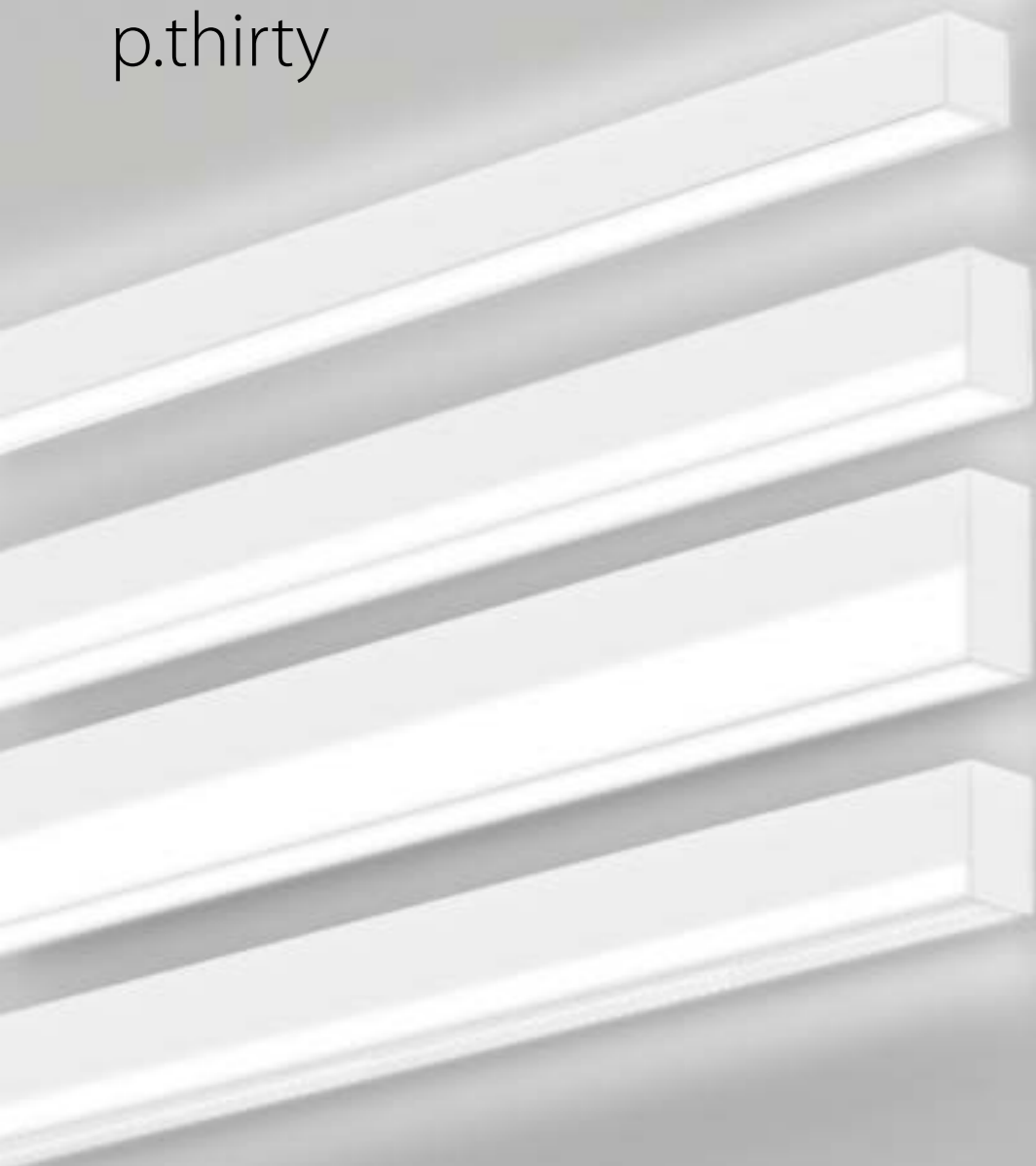

1 SIZE

- 557 mm (only non-dim)
- 827 mm
- 1187 mm
- 1457 mm
- 2899 mm
- 3531 mm
- 4341 mm

2 COLOUR

- 055** silver
- 082** white
- 118** black
- 145** RAL of your choice
- 289**
- 353**
- 434**

3 DIRECT/INDIRECT

- direct **1**
- direct/indirect **2**

4 LED

- 2700 K, CRI > 90
- 3000 K, CRI > 90
- 4000 K, CRI > 90
- 4000 K, CRI > 80

5 OUTPUT / CONTROL

- 927** low output non-dim
- 930** low output DALI
- 940** high output DALI
- 840** high output non dim (only 057)

6 OPTIC

- satiné **S**
- U-shaped satiné, 15 mm **U**
- U-shaped satiné, 34 mm **Q**
- jet black & light **J** **NEW**
- U-shaped jet black microprism, 15 mm* **V**

* UGR-optimised, configure online

P30W 1-2-3-4-5-6

P30W082-9016C1930H3S wall, 827 mm, white, IP 20, CRI > 90, direct, 3000 K, high output DALI, satiné (order sample)

► Configure online on KATALOG.PLANLICHT.COM

LUMINOUS FLUX (LM)/SYSTEM POWER (W), CRI > 80

4000 K satiné	direct		direct/indirect		KG
	low output	high output	low output	high output	
557 mm	930 lm / 8W	1324 lm / 11,5W	1313 lm / 9,8W	1862 lm / 14W	0,6 kg
827 mm	1388 lm / 10,5W	1981 lm / 15,5W	2359 lm / 15,5W	3348 lm / 22W	0,8 kg
1187 mm	1999 lm / 14,5W	2855 lm / 21 W	3755 lm / 25W	5329 lm / 36W	1,1 kg
1457 mm	2457 lm / 17W	3512 lm / 25W	4802 lm / 31 W	6818 lm / 44 W	1,3 kg
2899 mm	4895 lm / 34W	7008 lm / 50W	9992 lm / 63W	14200 lm / 91 W	2,5 kg
3531 mm	5961 lm / 43W	8537 lm / 62W	12242 lm / 77W	17398 lm / 112W	3,0 kg
4341 mm	7331 lm / 51 W	10503 lm / 74W	14992 lm / 95 W	21315 lm / 137W	3,7 kg

(based on optic Q)

COMPARE COVER 1457 MM, 4000 K, CRI > 80

cover	low output	high output	low output	high output
satiné	2457 lm	3512 lm	4802 lm	6818 lm
jet black & light	506 lm	723 lm	2851 lm	4029 lm
U-shaped satiné (15 mm)	2588 lm	3710 lm	4933 lm	7015 lm
U-shaped satiné (34 mm)	2724 lm	3903 lm	5069 lm	7209 lm
U-shaped jet black microprism	1419 lm	723 lm	3764 lm	5326 lm

COMPARE LIGHT COLOUR 1457 MM, SATINÉ

4000 K, CRI > 80	3512 lm
2700 K, CRI > 90	2637 lm
3000 K, CRI > 90	2769 lm
4000 K, CRI > 90	2862 lm

OPTIONAL ACCESSORY | PROTECTIVE COVER (INDIRECT)

P30-DIF-ID

LED-board cover, optional, reduces lumen output (max. 3,95 %), sold by the metre



Down to UGR ≤ 16 | up to 167 lm/W | up to 5197 lm/m | IEC 62471: Blue light hazard: RG ≤ 1 | DALI push switchDIM

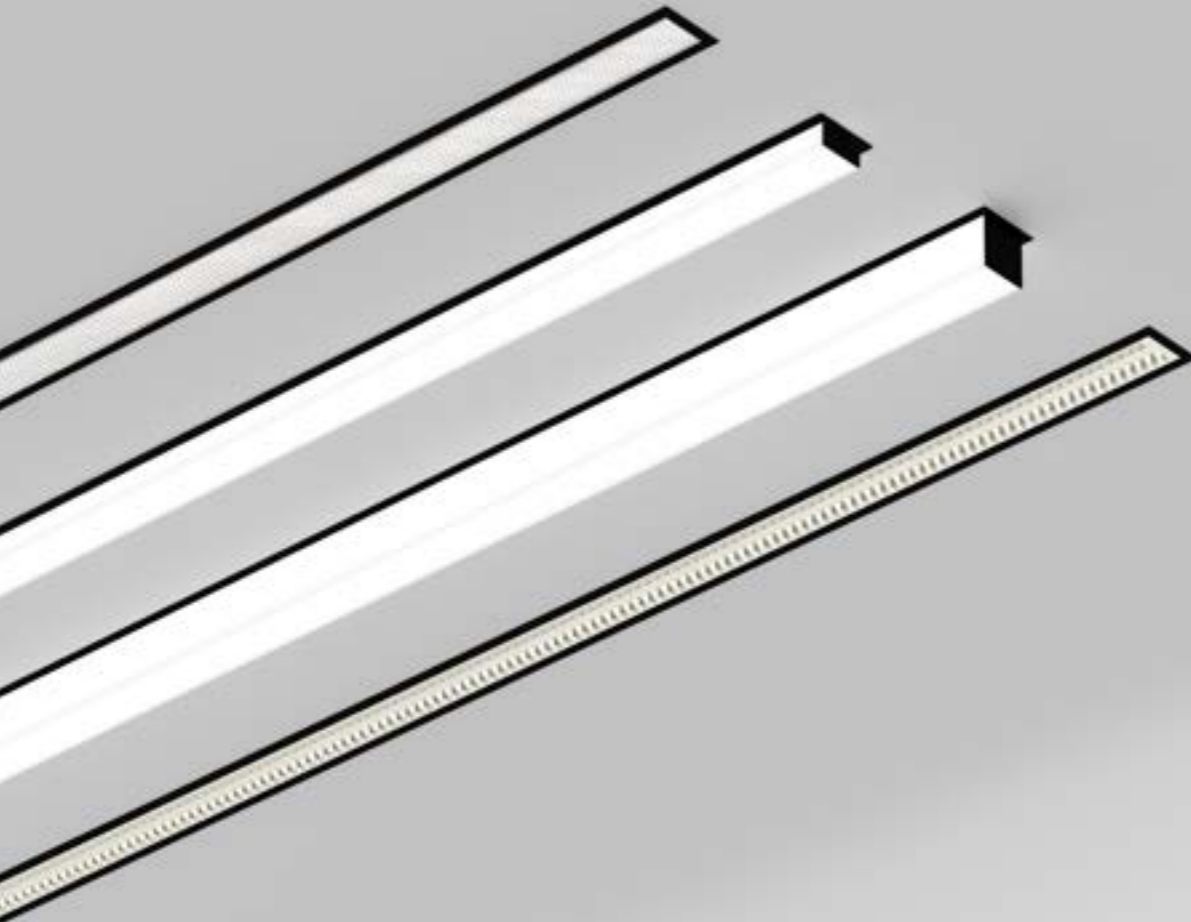

1 SIZE	2 COLOUR	3 INGRESS PROTECTION
565 mm (non dim only)	056 silver	9006 IP20
835 mm	083 white	9016
1195 mm	119 black	9005
1465 mm	146 RAL of your choice	
2907 mm	290	
3539 mm	353	
4349 mm	434	

4 LED	4 OUTPUT / CONTROL	5 OPTIC
2700 K, CRI > 90	927 DIFFUSER	satiné
3000 K, CRI > 90	930 low output non-dim	jet black & light
4000 K, CRI > 90	940 low output DALI	microprism*
4000 K, CRI > 80	840 high output non dim (565 mm)	U-shaped satiné, 15 mm
	high output DALI	U-shaped satiné, 34 mm
	OBD	U-shaped jet black microprism, 15 mm*
	high output non dim	Opto-Balance Darklight®
	high output DALI	BAP high-gloss black chrome*
	very high output non-dim (not 835 mm)	Opto-Balance Darklight®
	very high output DALI (not 835 mm)	BAP high-gloss copper*
		Opto-Balance Darklight®
		BAP high-gloss gold*
		Opto-Balance Darklight®
		BAP high-gloss silver*

P30E 1-2-3-4-5-6

P30E353-9016C1930H35 recessed frame, 3539 mm, white, IP20, direct, 3000 K, CRI > 90, high output DALI, satiné (order sample)

Configure online on KATALOG.PLANLICHT.COM

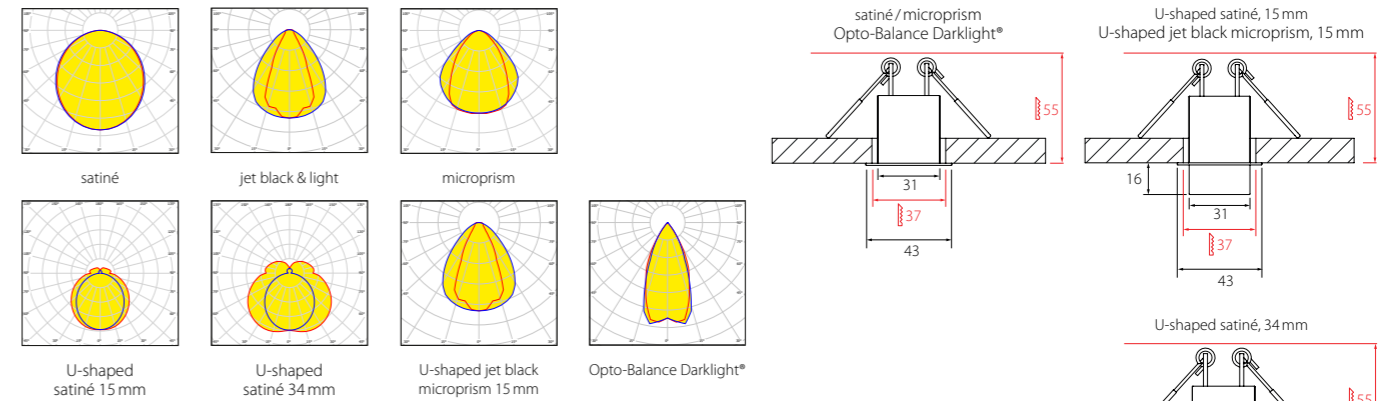

LUMINOUS FLUX (LM) / SYSTEM POWER (W)

4000 K satiné CRI > 80	low output	high output	
565 mm	930 lm / 8W	1324 lm / 11,5W	0,7 kg
827 mm	1388 lm / 10,5W	1981 lm / 15,5W	0,9 kg
1187 mm	1999 lm / 14,5W	2855 lm / 21 W	1,2 kg
1457 mm	2457 lm / 17W	3512 lm / 25W	1,4 kg
2899 mm	4895 lm / 34W	7008 lm / 50W	2,7 kg
3531 mm	5961 lm / 43W	8537 lm / 62W	3,3 kg
4341 mm	7331 lm / 51 W	10503 lm / 74W	4,0 kg

(based on optic Q)

COMPARE COVER 1457 MM, 4000 K, CRI > 80

	low output	high output	very high output
satiné	2457 lm	3512 lm	
jet black & light	506 lm	723 lm	
microprism*	2534 lm	3624 lm	
U-shaped satiné (15 mm)	2588 lm	3710 lm	
U-shaped satiné (34 mm)	2724 lm	3903 lm	
U-shaped jet black microprism (15 mm)	1419 lm	2020 lm	
Opto-Balance Darklight® high-gloss silver		1941 lm	3836 lm

*Der angegebene Lichtstrom bezieht sich auf die Leuchte mit klarer mikroprismatischer Abdeckung. Die Leuchte wird mit satiniertes Folie zur Erhöhung der Homogenität geliefert (Direkt strahlend: -13,9%, direkt/indirekt strahlend: -6,9% Lichtstrom). Die angegebenen Lichtstromwerte (lm) beziehen sich auf Leuchten mit einem weißen Gehäuse (RAL 9016). Je nach Gehäusefarbe und Länge reduzieren sich diese entsprechend (bezieht sich nur auf U-förmige Abdeckungen).

The indicated luminous flux corresponds to the luminaire with a clear microprismatic diffuser. The luminaire is delivered with a satinized-foil for increased homogeneity (direct: -13,9%, direct-indirect: -6,9% luminous flux). All figures of luminous flux (lm) are for fixtures with white housing (RAL 9016). Depending on the housing colour and length, the luminous flux is reduced accordingly. This only applies to U-shaped optics.

Le flux lumineux indiqué correspond au luminaire avec diffuseur microprismatique transparent. Le luminaire est livré avec un film satiné pour optimiser l'homogénéité (direct: -13,9%, direct-indirect: -6,9% sur le flux lumineux).

Les valeurs de flux lumineux (lm) indiquées se réfèrent aux luminaires à corps blanc (RAL 9016). En fonction de la couleur du corps et de la longueur, celles-ci sont réduites en conséquence (se réfère uniquement aux caches en forme de U).

P.THIRTY PROFILE SYSTEM



Down to UGR ≤ 16 | up to 160 lm/W | up to 2905 lm/m | IEC 62471: Blue light hazard: RG 0 | push switchDIM

NEW p.thirty IP 44

Einbauleuchte
Recessed luminaire
Luminaire encastré

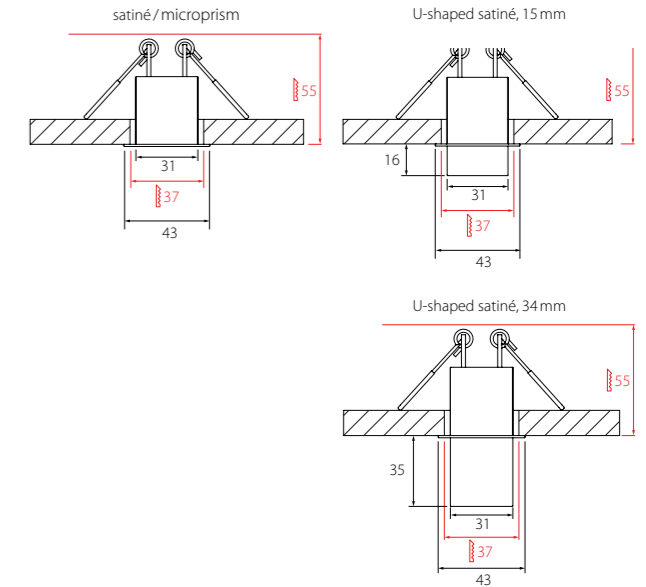
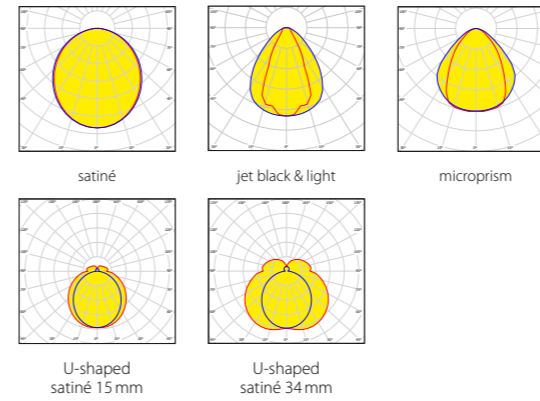
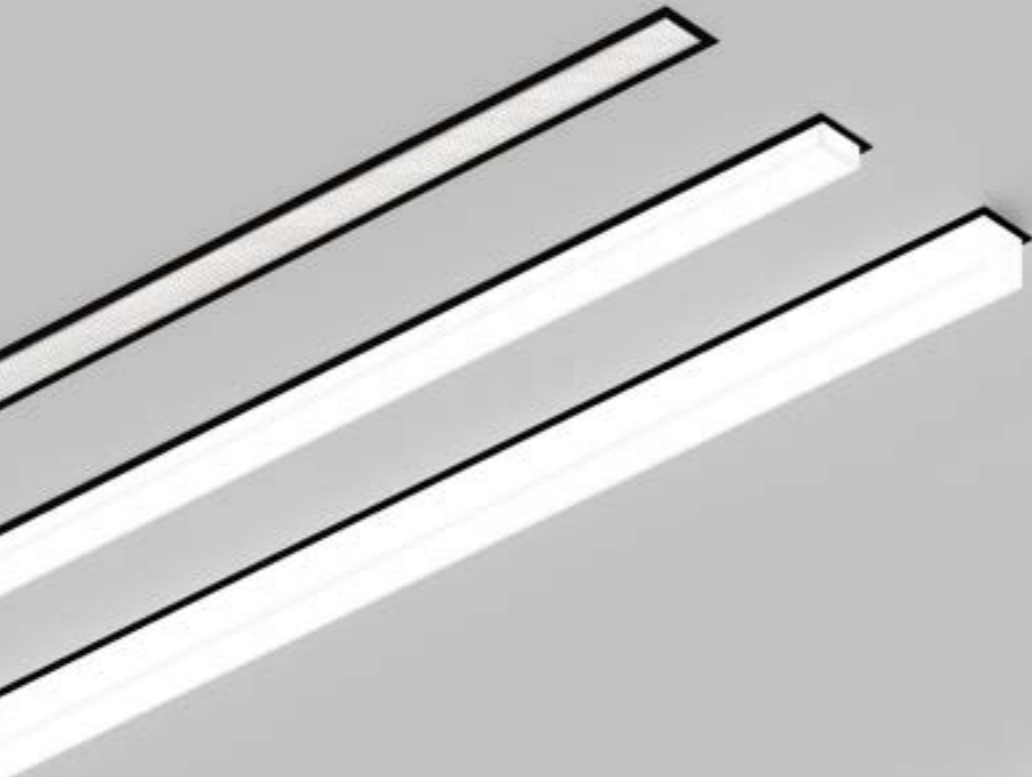

LUMINOUS FLUX (LM) / SYSTEM POWER (W)

4000 K satiné CRI > 80	low output	high output	
557 mm	930lm/8W	1324lm/11,5W	0,7kg
827 mm	1388lm/10,5W	1981lm/15,5W	0,9kg
1187 mm	1999lm/14,5W	2855lm/21W	1,2kg
1457 mm	2457lm/17W	3512lm/25W	1,4kg

(based on optic Q)

COMPARE COVER 1457 MM, 4000 K, CRI > 80

	low output	high output
satiné	2457lm	3512lm
jet black & light	506lm	723lm
microprism*	2534lm	3624lm
U-shaped satiné (15 mm)	2588lm	3710lm
U-shaped satiné (34 mm)	2724lm	3903lm

*Der angegebene Lichtstrom bezieht sich auf die Leuchte mit klarer mikroprismatischer Abdeckung. Die Leuchte wird mit satiniertes Folie zur Erhöhung der Homogenität geliefert (Direkt strahlend: -13,9%, direkt/indirekt strahlend: -6,9% Lichtstrom). Die angegebenen Lichtstromwerte (lm) beziehen sich auf Leuchten mit einem weißen Gehäuse (RAL 9016). Je nach Gehäusefarbe und Länge reduzieren sich diese entsprechend (bezieht sich nur auf U-förmige Abdeckungen).

The indicated luminous flux corresponds to the luminaire with a clear microprismatic diffuser. The luminaire is delivered with a satined-foil for increased homogeneity (direct: -13,9%, direct-indirect: -6,9% luminous flux). All figures of luminous flux (lm) are for fixtures with white housing (RAL 9016). Depending on the housing colour and length, the luminous flux is reduced accordingly. This only applies to U-shaped optics.

Le flux lumineux indiqué correspond au luminaire avec diffuseur microprismatique transparent. Le luminaire est livré avec un film satiné pour optimiser l'homogénéité (direct: -13,9%, direct-indirect: -6,9% sur le flux lumineux). Les valeurs de flux lumineux (lm) indiquées se réfèrent aux luminaires à corps blanc (RAL 9016). En fonction de la couleur du corps et de la longueur, celles-ci sont réduites en conséquence (se réfère uniquement aux caches en forme de U).

1 SIZE

- 565 mm (non dim only)
- 835 mm
- 1195 mm
- 1465 mm

2 COLOUR

- 056** silver
- 083** white
- 119** black
- 146** RAL of your choice

3 INGRESS PROTECTION

IP44 **P**

4 LED

- 2700 K, CRI > 90
- 3000 K, CRI > 90
- 4000 K, CRI > 90
- 4000 K, CRI > 80

4 OUTPUT / CONTROL

- DIFFUSER**
- 927** low output non-dim **L1**
 - 930** low output DALI **L3**
 - 940** high output non dim (565 mm) **H1**
 - 840** high output DALI **H3**

5 OPTIC

- satiné **S**
- jet black & light **J** **NEW**
- microprism* **M**
- U-shaped satiné, 15 mm **U**
- U-shaped satiné, 34 mm **Q**

* UGR-optimised, configure online

P30E **1-2-3-4-5-6**

P30E146-9016P1930H35 recessed frame, 1465 mm, white, IP44, direct, 3000 K, CRI > 90, high output DALI, satiné (order sample)

➔ [Configure online on KATALOG.PLANLICHT.COM](#)

P.THIRTY IP 44 | RECESSED

P.THIRTY PROFILE SYSTEM



Down to UGR ≤ 19 | up to 160lm/W | up to 2905lm/m | IEC 62471: Blue light hazard: RG 0 | push switchDIM



DIFFERENT SHAPES / DIFFUSERS

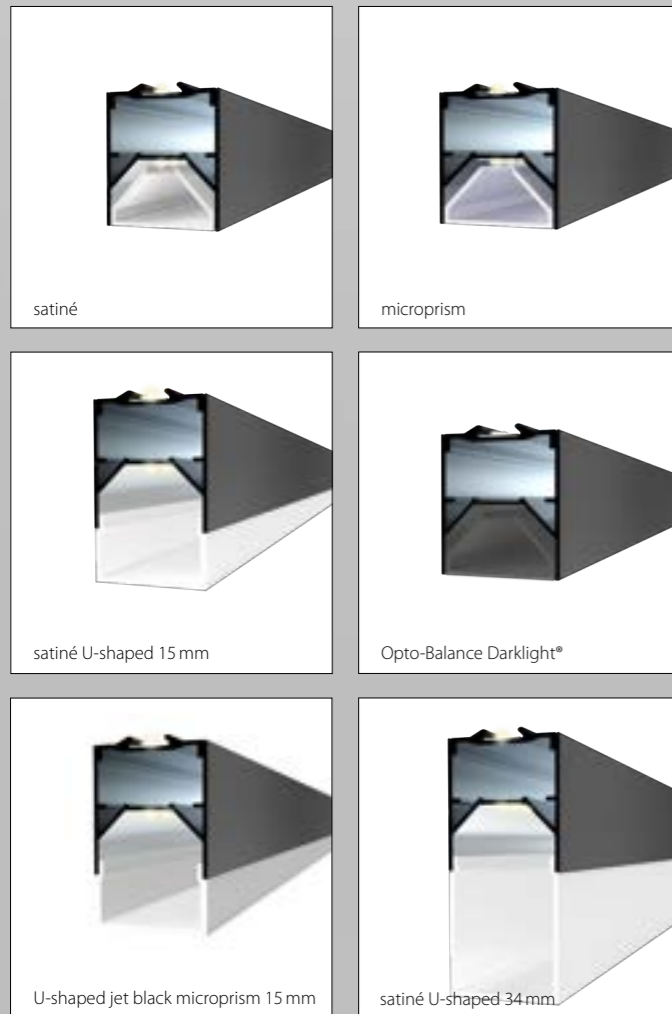

90° CONNECTORS

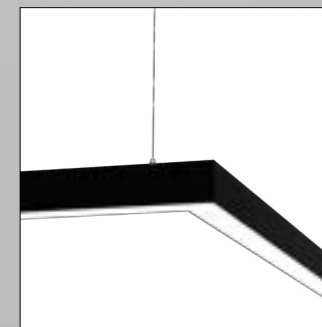

ZENIT XXS SEGMENTS



DIFFERENT HOUSING COLOURS

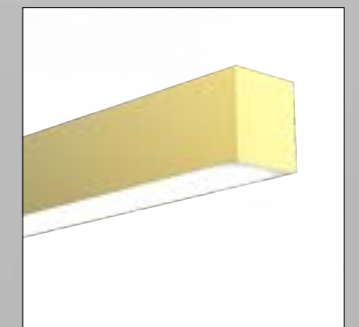

MIX & MATCH MOUNTING TYPES

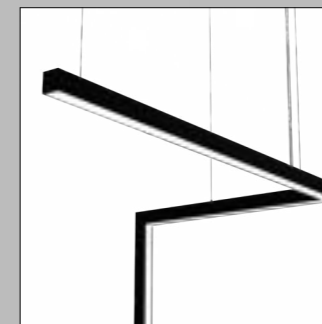

DIFFERENT DIFFUSERS

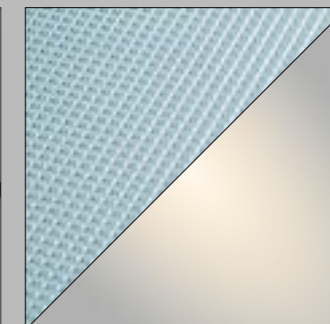

DIFFERENT COLOUR CABLES

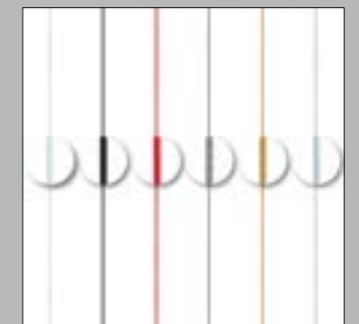

1 MOUNTING

- Surface mounted
- Pendant
- Wall mounted
- Recessed

A
H
W
E

4 DIRECT/INDIRECT

- direct
- direct/indirect

1
2

5 LED

- LF927 2700 K, CRI > 90
- LF930 3000 K, CRI > 90
- LF940 4000 K, CRI > 90
- LF840 4000 K, CRI > 80

927
930
940
840

6 OUTPUT/CONTROL

- low output non-dim (not OBD)
- low output DALI (not OBD)
- high output non-dim (recessed with diffuser 054 & 063 only)
- high output DALI
- very high output non-dim (direct/OBD only)
- very high output DALI (direct/OBD only)

L1
L3
H1
H3
V1
V3

7 OPTIC

- satiné
- microprism*
- U-shaped satiné, 15 mm
- U-shaped satiné, 34 mm
- U-shaped jet black microprism, 15 mm*
- NEW** Opto-Balance Darklight* BAP high-gloss black chrome*
- NEW** Opto-Balance Darklight* BAP high-gloss copper*
- NEW** Opto-Balance Darklight* BAP high-gloss gold*
- NEW** Opto-Balance Darklight* BAP high-gloss silver*

S
M
U
Q
V
Z
K
G
B

* UGR-optimised, configure online

3 COLOUR

- silver **9006**
- white **9016**
- black **9005**
- RAL of your choice

2 FORM / SIZE

Segment L-Form, horizontal	LFH	Linear segment 2254 mm	225
Segment L-Form, vertical (not H, OBD)	LFV	Linear segment 2344 mm	234
Segment T-Form, horizontal (not W)	TFH	Linear segment 2434 mm	243
Segment X-Form, horizontal (not W)	XFH	Linear segment 2524 mm	252
Linear segment 542 mm (only L1, direct, recessed H1)	054	Linear segment 2614 mm	261
Linear segment 632 mm (only L1, direct, recessed H1)	063	Linear segment 2704 mm	270
Linear segment 722 mm	072	Linear segment 2794 mm	279
Linear segment 812 mm (not very high output)	081	Linear segment 2884 mm	288
Linear segment 902 mm (not very high output)	090	Linear segment 2974 mm	297
Linear segment 992 mm (not di/id, very high output)	099	Linear segment 3064 mm	306
Linear segment 1082 mm (not di/id, very high output)	108	Linear segment 3156 mm	315
Linear segment 1172 mm (not di/id, very high output)	117	Linear segment 3246 mm	324
Linear segment 1262 mm	126	Linear segment 3336 mm	333
Linear segment 1352 mm	135	Linear segment 3426 mm	342
Linear segment 1442 mm	144	Linear segment 3516 mm	351
Linear segment 1532 mm	153	Linear segment 3606 mm	360
Linear segment 1624 mm	162	Linear segment 3696 mm	369
Linear segment 1714 mm	171	Linear segment 3786 mm	387
Linear segment 1804 mm	180	Linear segment 3966 mm	396
Linear segment 1894 mm	189	Linear segment 4056 mm	405
Linear segment 1984 mm	198	Linear segment 4146 mm	414
Linear segment 2074 mm	207	Linear segment 4236 mm	423
Linear segment 2164 mm	216	Linear segment 4326 mm	432

LUMINOUS FLUX (LM) / SYSTEM POWER (W), CRI > 80

4000 K satiné	low output	direct		direct/indirect	
		high output	very high output	low output	high output
542 mm	930 lm / 8W	-		-	-
632 mm	1082 lm / 8,9W	-		-	-
722 mm	1236 lm / 9,8W	1762 lm / 14W		2010 lm / 13,5W	2853 lm / 19,5W
812 mm	1388 lm / 10,5W	1981 lm / 15,5W		2359 lm / 15,5W	3348 lm / 22W
902 mm	1541 lm / 11,5W	2199 lm / 16,5W		2708 lm / 17W	3843 lm / 25W
1262 mm	2151 lm / 15,5W	3074 lm / 22W		4103 lm / 27W	5825 lm / 39W
1442 mm	2457 lm / 17W	3512 lm / 25W		4802 lm / 31W	6818 lm / 44W
1714 mm	2914 lm / 22W	4167 lm / 32W		5848 lm / 36W	8304 lm / 52W
2254 mm	3829 lm / 28W	5479 lm / 40W		7352 lm / 49W	10449 lm / 71W
3064 mm	5201 lm / 36W	7445 lm / 52W		10692 lm / 67W	15193 lm / 97W
3606 mm	6113 lm / 44W	8755 lm / 64W		12788 lm / 80W	18174 lm / 116W
4326 mm	7331 lm / 51W	10503 lm / 74W		14992 lm / 95W	21315 lm / 137W
LFH	1541 lm / 11,5W	2199 lm / 16,5W		2708 lm / 17W	3843 lm / 25W
LFV	1236 lm / 9,8W	1762 lm / 14W		2206 lm / 14,5W	3129 lm / 21W
TFH	1541 lm / 11,5W	2199 lm / 16,5W		2708 lm / 17W	3843 lm / 25W
XFH	1541 lm / 11,5W	2199 lm / 16,5W		2905 lm / 17W	4119 lm / 26W

COMPARE COVER 1442 MM, 4000 K, CRI > 80

	2457 lm	3512 lm	4802 lm	6818 lm
satiné				
microprism	2533 lm	3625 lm	4879 lm	6927 lm
U-shaped satiné (15 mm)	2587 lm	3708 lm	4932 lm	7015 lm
U-shaped satiné (34 mm)	2724 lm	3902 lm	5070 lm	7207 lm
U-shaped jet black microprism	1417 lm	2020 lm	3765 lm	5324 lm
jet black & light	506 lm	723 lm	2851 lm	4029 lm
Opto-Balance Darklight* high-gloss silver	-	1941 lm	3836 lm	5102 lm

OPTIONAL ACCESSORY

PROTECTIVE COVER (INDIRECT)

P30-DIF-ID

LED-board cover, optional, reduces lumen output (max. 3,95%), sold by the metre

P30-1 2 3 C 4 5 6

P30-W1629016C2940H3S Wall mounted, Linear segment 1624 mm, white, IP20, direct/indirect, 4000 K, CRI > 90, high output DALI, satiné (order sample)

► Configure online on KATALOG.PLANLICHT.COM



Down to UGR ≤ 16 | up to 171 lm/W | up to 5316 lm/m | IEC 62471: Blue light hazard: RG ≤ 1 | DALI push switchDIM

NEW zenit XXS segment spots
for p.thirty

Systeme | Segmente
Systems | Segments
Systèmes | Segment

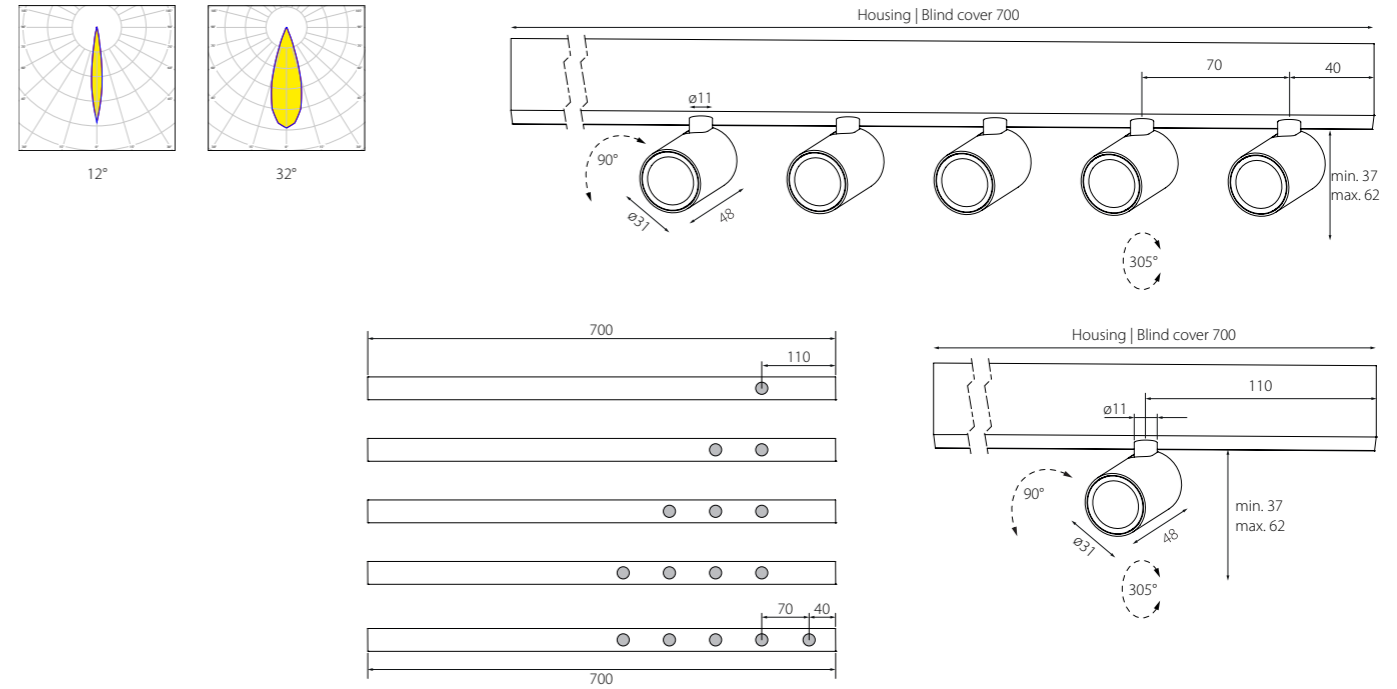

LUMINOUS FLUX (LM) / SYSTEM POWER (W)

	12°					32°				
	1 spot (7W)	2 spots (11,5W)	3 spots (16,5W)	4 spots (21W)	5 spots (26W)	1 spot (7W)	2 spots (11,5W)	3 spots (16,5W)	4 spots (21W)	5 spots (26W)
LF927 2700K	183lm	366lm	549lm	732lm	915lm	272lm	544lm	816lm	1088lm	1360lm
LF930 3000K	189lm	378lm	567lm	756lm	945lm	280lm	560lm	840lm	1120lm	1400lm
LF940 4000K	197lm	394lm	591lm	788lm	985lm	292lm	584lm	876lm	1168lm	1460lm

WEIGHT

	non-dim	DALI
1 spot	720g	740g
2 spots	780g	800g
3 spots	840g	860g
4 spots	900g	920g
5 spots	960g	980g

based on recessed mounted version

1 PROFILE MOUNTING

- surface
- pendant
- recessed

2 SPOTS

- A** 1 spot
- H** 2 spots
- E** 3 spots
- 4 spots
- 5 spots

3 COLOUR

- silver
- white
- black
- aluminium natural transparent

4 LED

- 2700K, CRI > 90
- 3000K, CRI > 90
- 4000K, CRI > 90

5 CONTROL

- 927** non-dim
- 930** DALI
- 940**

6 BEAM ANGLE

- X1** 12°
- X3** 32°

P30-1 ZBS 3 N 4 5 6

P30-AZBS1NATSW927X11 surface mounted p.thirty segment, zenit XXS surface variable, single spot, black tube, aluminium natural transparent spot, black housing & blank cover, 2700K, CRI > 90, non-dim, 12°, IP 20 (order sample) [Configure online on KATALOG.PLANLICHT.COM](#)

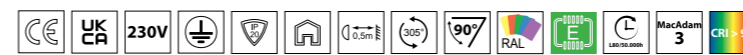

Down to UGR ≤ 16 | IEC 62471: Blue light hazard: RG ≤ 1 | DALI push switchDIM

NEW zenit XXS segment
for p.thirty

Systeme | Segmente
Systems | Segments
Systèmes | Segment

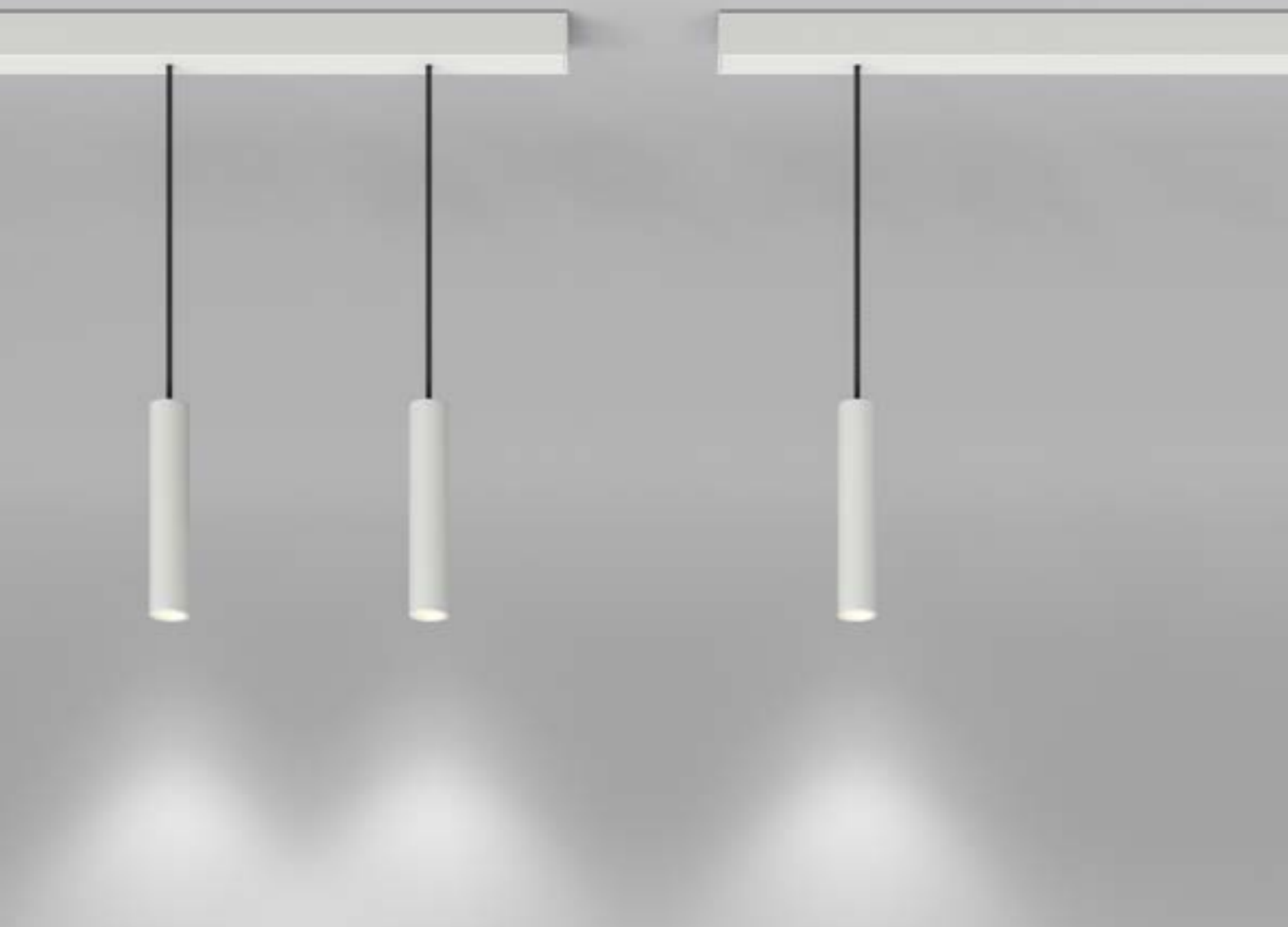

1 PROFILE MOUNTING

- surface
- pendant
- recessed

2 PENDANTS

- | | | |
|----------|------------|----------|
| A | 1 pendant | 1 |
| H | 2 pendants | 2 |
| E | | |

3 COLOUR

- | | | | | | |
|--|-------------------------------|-----------|------|-----------------------|-----------|
| | silver | SI | spot | housing & blank cover | SI |
| | white | WS | | | WS |
| | black | SW | | | SW |
| | aluminium natural transparent | AT | | | SW |

4 LED

- 2700 K, CRI > 90
- 3000 K, CRI > 90
- 4000 K, CRI > 90

5 CONTROL

- | | | |
|--|---------|-----------|
| | non-dim | X1 |
| | DALI | X3 |

6 BEAM ANGLE

- | | | |
|--|-----|----------|
| | 12° | 1 |
| | 32° | 3 |

P30-1 ZHS 3 N 4 5 6

P30-AZHS2NATSW927X11 surface mounted p.thirty segment, 2 zenit XXS pendants, black tube, aluminium natural transparent spot, black housing & blank cover, 2700 K, CRI > 90, non-dim, 12°, IP 20 (order sample)

► [Configure online on KATALOG.PLANLICHT.COM](https://www.planlicht.com)

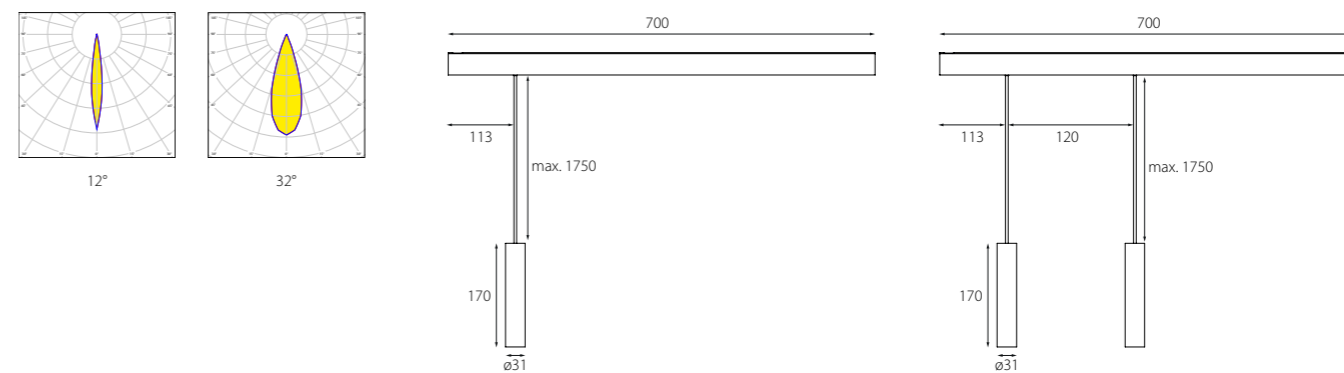

LUMINOUS FLUX (LM) / SYSTEM POWER (W)

	12°		32°	
	1 pendant (7W)	2 pendants (11,5W)	1 pendant (7W)	2 pendants (11,5W)
LF927 2700 K	183 lm	366 lm	272 lm	544 lm
LF930 3000 K	189 lm	378 lm	280 lm	560 lm
LF940 4000 K	197 lm	394 lm	292 lm	584 lm

WEIGHT

	non-dim	DALI
1 pendant	940 g	960 g
2 pendants	1240 g	1260 g

based on recessed mounted version

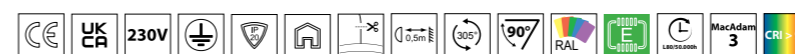

Down to UGR ≤ 16 | IEC 62471: Blue light hazard: RG ≤ 1 | DALI push switchDIM

FARBKARTEN | GEHÄUSE & KABEL

COLOUR CHARTS | HOUSING & CABLES

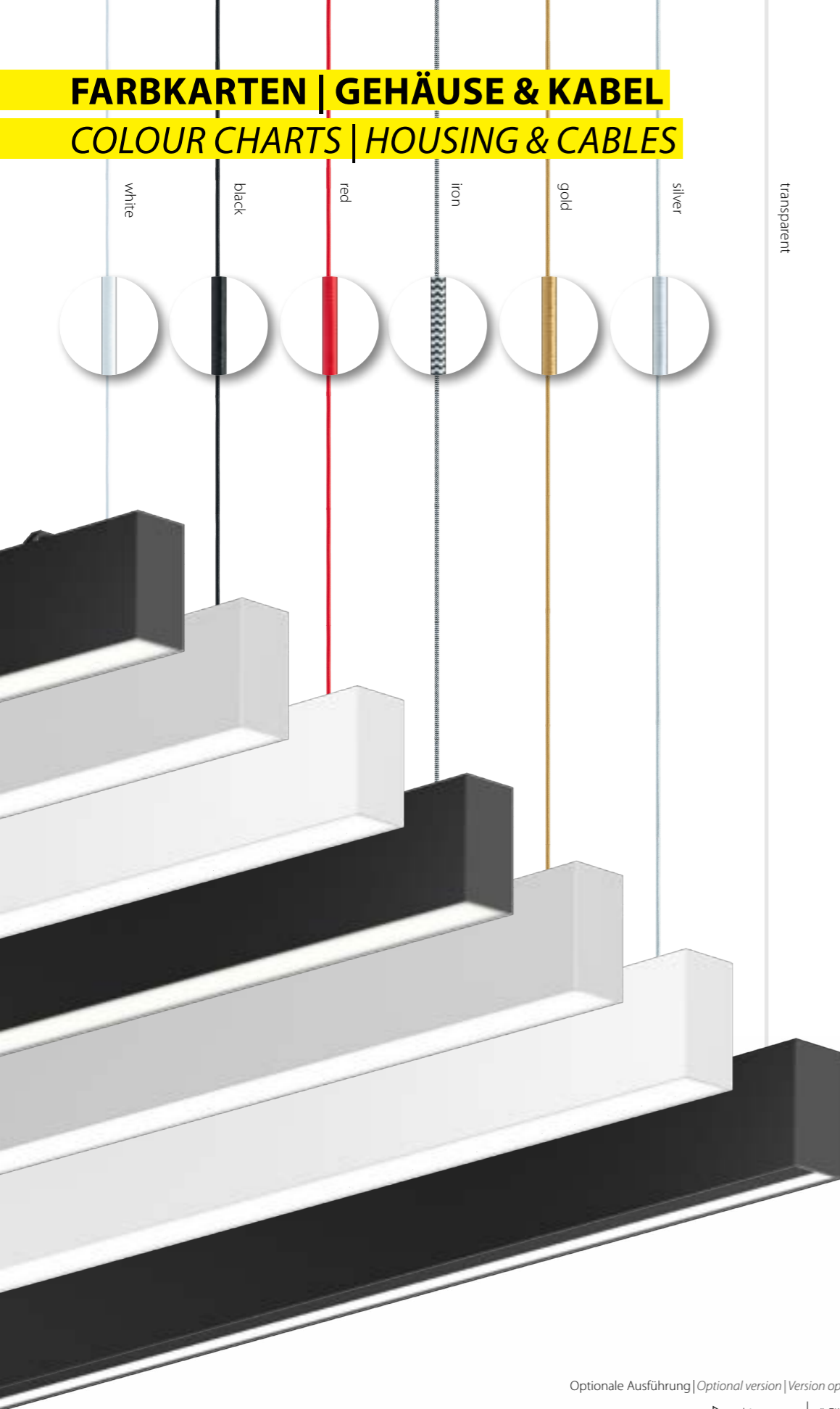

Optionale Ausführung | Optional version | Version optionnelle

▷ white	*-EIN-WHITE
▶ black	*-EIN-BLACK
▷ red	*-EIN-RED
▷ iron	*-EIN-IRON
▷ gold	*-EIN-GOLD
▷ silver	*-EIN-SILVER

1750mm
5x0,75mm²

Transparentes Kabel inkl. (Standard Version)



für besondere Anfragen

RAL NACH WAHL | OPTIONALE GEHÄUSEFARBEN

RAL OF YOUR CHOICE | OPTIONAL HOUSING COLOURS



FARBKARTEN | DIFFUSOREN & OPTIKEN

COLOUR CHARTS | DIFFUSERS & OPTICS



A large grid area for taking notes, consisting of 25 columns and 30 rows of small squares.

WICHTIGE HINWEISE

Dieser Katalog richtet sich ausschliesslich an gewerbliche Kunden. Die in diesem Katalog angegebenen Werte sind Bemessungswerte und unterliegen produktionsbedingten Toleranzen*. Alle angeführten Angaben – insbesondere Grössen-, Material-, Farb- und technische Angaben – entsprechen dem Stand zum Zeitpunkt des Drucks und dienen ausschliesslich zur Information. Der Herausgeber haftet nicht für Satz- und Druckfehler sowie für Abweichungen der Produkte von Abbildungen und Angaben. PLANLICHT behält sich vor, jederzeit ohne Ankündigung Änderungen an Produkten vor zu nehmen. Es gelten die Allgemeinen Geschäftsbedingungen der planlicht GmbH & Co KG, die unter WWW.PLANLICHT.COM eingesehen werden können.

Technische Kennzahlen, angeführte Werte und die Piktogramme betreffen zumindest einen aber nicht zwingend alle Artikel der jeweiligen Leuchtenfamilie, exakte Angaben je Artikel finden Sie im Online-Katalog bzw. in PLANLICHT-Verkaufsbelegen und Datenblättern.

* Leistung, Lichtstrom und Farbtemperatur unterliegen durch den Einsatz von elektronischen Bauteilen produktionsbedingten Toleranzen. Toleranzen Leistung und Lichtstrom: +/- 10%. Toleranz Farbtemperatur: +/- 150 K. Lichtstrom dynamisch weiss bei 2700 K.

IMPORTANT REMARKS

This catalogue is reserved for professionals only. The values published in this catalogue are rated values, which can slightly change for reasons related to the production process. The published data such as dimensions, materials, colours and technical data are valid at time of printing, and exclusively provided for informational purposes. The editor takes no responsibility for typographical and print errors, as well as for any differences in the products, pictures and data. PLANLICHT reserves the right to change the products at any time and without any notice. The Terms and Conditions of planlicht GmbH & Co KG (available on WWW.PLANLICHT.COM) shall apply.*

Key technical specifications, listed values as well as the pictogram bar relate to at least one but not necessarily all items of the respective luminaire family, exact details for each item can be found in the online web catalogue or in PLANLICHT sales documents and data sheets.

* The power output, luminous flux and colour temperature can be slightly different due to specific electronic components used in the manufacturing process. The power output and luminous flux can differ by +/- 10%. The colour temperature can differ by +/- 150 K. Luminous flux dynamic white at 2700 K.

REMARQUES IMPORTANTES

Ce catalogue est exclusivement destiné aux professionnels. Les valeurs publiées dans ce catalogue sont des valeurs calculées, pouvant légèrement changer pour des raisons liées au processus de fabrication. Les données techniques et autres informations (dimensions, matériaux, couleurs...) sont celles applicables au moment de l'impression du catalogue, et uniquement fournies à titre informatif. L'éditeur décline toute responsabilité en cas d'erreur de frappe, d'impression et pour tout autre différence concernant les produits, images et données publiées. PLANLICHT se réserve le droit de modifier les produits à sa discrétion, à tout moment et sans préavis. Les conditions générales de vente de planlicht GmbH & Co KG applicables sont consultables sur WWW.PLANLICHT.COM.*

Les caractéristiques techniques, les valeurs indiquées et la barre de pictogrammes concernent au moins un article de la famille de luminaires concernée, mais pas nécessairement tous. Vous trouverez des informations exactes par article dans le catalogue en ligne ou dans les documents de vente et les fiches techniques de PLANLICHT.

* La puissance, le flux lumineux et la température de couleur peuvent légèrement différer en raison de l'utilisation de composants électroniques spécifiques dans le processus de production. La puissance et le flux lumineux peuvent différer de +/- 10%. La température de couleur peut différer de +/- 150 K. Flux lumineux blanc dynamique à 2700 K.



6134 Vomp, Austria, Au 25
Tel. +43-5242-71608, Fax +43-5242-71283
info@planlicht.com
WWW.PLANLICHT.COM

IMPRINT

Publisher: planlicht GmbH & Co. KG, Vomp
Creative Concept: Katrin Atzinger
Graphic Design: Beatrice Praxmarer, Christoph Höflinger
Print: Himmer GmbH Druckerei & Verlag, Augsburg/DE
© 2024



WWW.PLANLICHT.COM